

30" ELMDALE CHARCOAL BLACK VANITY WITH OUTLET - VANITY CABINET ONLY

SKU: 561766
Code: SH66230087



FEATURES

Material: Wood
Product Finish: Charcoal Black
Number of Doors: 2
Number of Drawers: 2
Soft-Close Hinges: Yes
Soft-Close Slides: Yes
Full Extension Drawer Slides: Yes
Dovetail Drawers: Yes
Adjustable Shelves: No
Electrical Outlet: Yes
Hardware Finish: Black
Hardware Material: Zinc
Built-In Adjusters: Yes

UL-962A, CAN/CSA-C22.2 No. 308, LISTED ID: BY213-D01



ADDITIONAL FEATURES

- Solid wood cabinet.
- Engineered wood panels.
- A built-in power box features two outlets and two USB ports.
- See Installation Instructions for directions to attach the vanity top and sink.
- All dimensions are ($\pm 1/2"$).

REVISED 3/23/2026

30" ELMDALE CHARCOAL BLACK VANITY WITH OUTLET - VANITY CABINET ONLY

SKU: 561766

Code: SH66230087

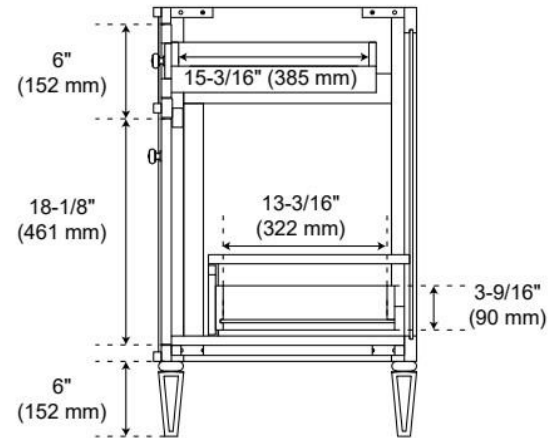
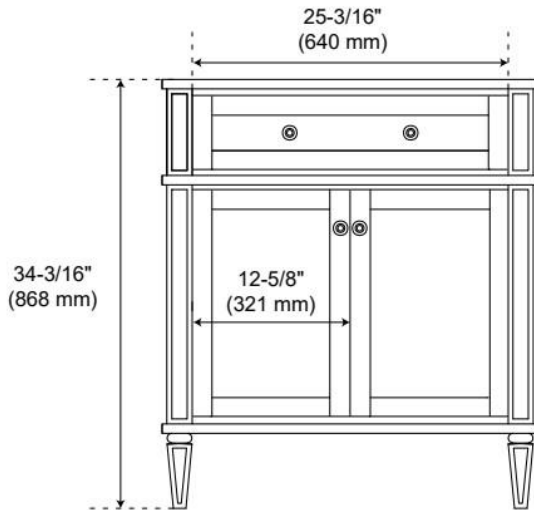
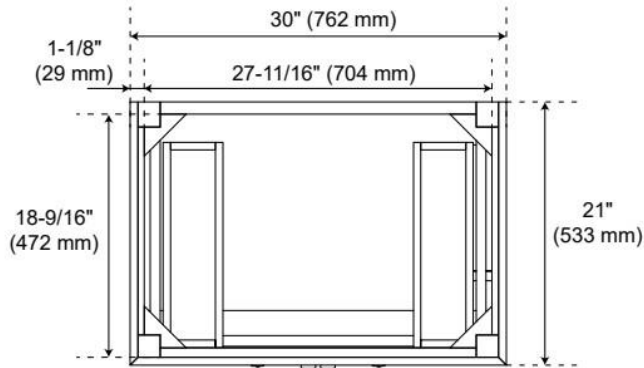

REVISED 3/23/2026