

67" ARRINGTON ACRYLIC FREESTANDING TUB

SKU: 930316-67

Code: SH480880, SH484655



FEATURES

Tub Material: Acrylic
Product Finish: White
Shape: Specialty
Tub Drain Placement: Center
Drain Included: Yes
Drain and Overflow Finish: White
Water Depth to Overflow: 18-3/4"
Water Capacity (Gallons): 74
Built-In Adjusters: Yes
Tub Weight Uncrated (lbs): 150
Optional Accessory: 428473

CSA B45.5/IAPMO Z124, Massachusetts Accepted, LISTED ID: SH112107*



ADDITIONAL FEATURES

- All dimensions are ($\pm 1/2$ ").
- Formed of two acrylic sheets, the air between acting as thermal insulator.
- Insulation option: increases heat retention and prevents condensation due to water and air temperature fluctuations.
- Optional Quick Connect Drop-In Drain Kit Includes:
 - Floor Plate, 1-1/2" PVC Pipe, 2" x 1-1/2" Trap Adapters, 1 Brass Threaded, 1 Brass Unthreaded Tailpiece and Plug.
 - Installs above your subfloor, but underneath your cement floor or tile, so you do not need access below the fixture.

REVISED 6/21/2024

67" ARRINGTON ACRYLIC FREESTANDING TUB

SKU: 930316-67

Code: SH480880, SH484655

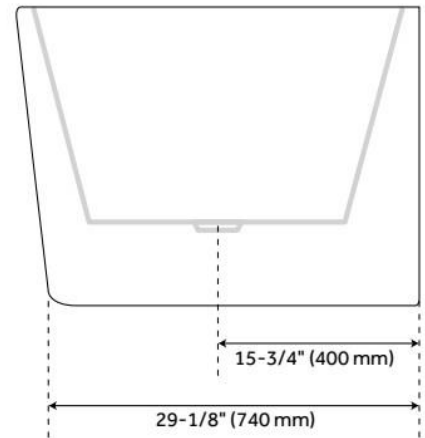
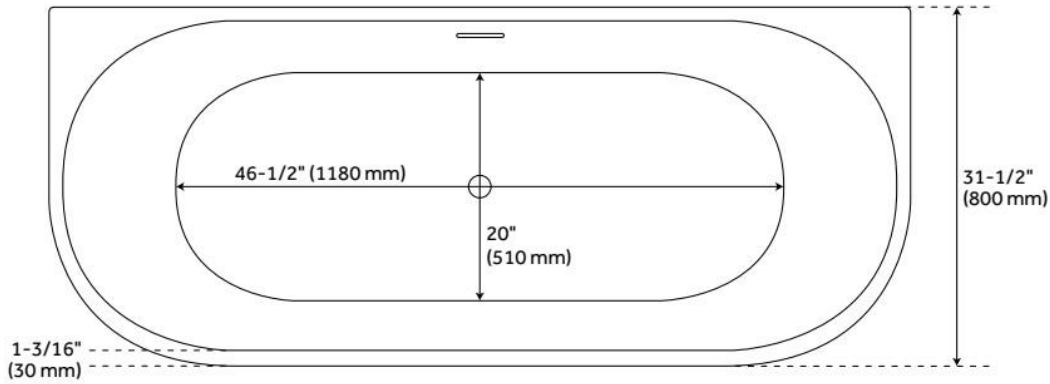

REVISED 6/21/2024