

# 96" ANDO BARN DOOR HARDWARE KIT

SKU: 950673

Code: HBD5001X96, HBD5911

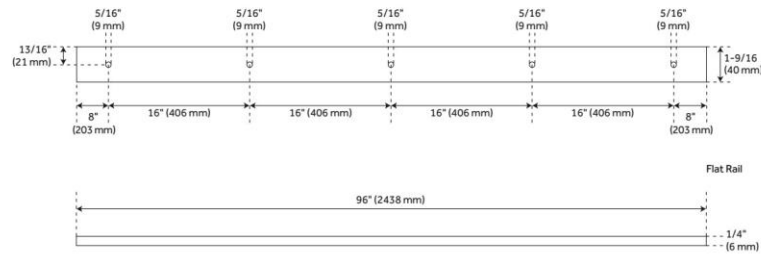

## FEATURES

## ADDITIONAL FEATURES

- Black and oil rubbed bronze barn door hardware kits are made of steel.
- Stainless steel barn door hardware kit is made of stainless steel.
- For doors up to 48" wide.
- Wheel: 4-3/4" diameter.
- Steel 1-1/4" diameter roller bearings.
- Track Size: 1/4" Steel, 1-1/2" x 96".
- Strap Size: 1/4" Steel, 13-1/2" x 1-1/2".
- Optional Soft Close Adapter:
  - Door weight needs to be 66-132 lbs and not exceeding 176 lbs for the soft-close function to work properly.

REVISED 7/10/2024

# 96" ANDO BARN DOOR HARDWARE KIT

SKU: 950673

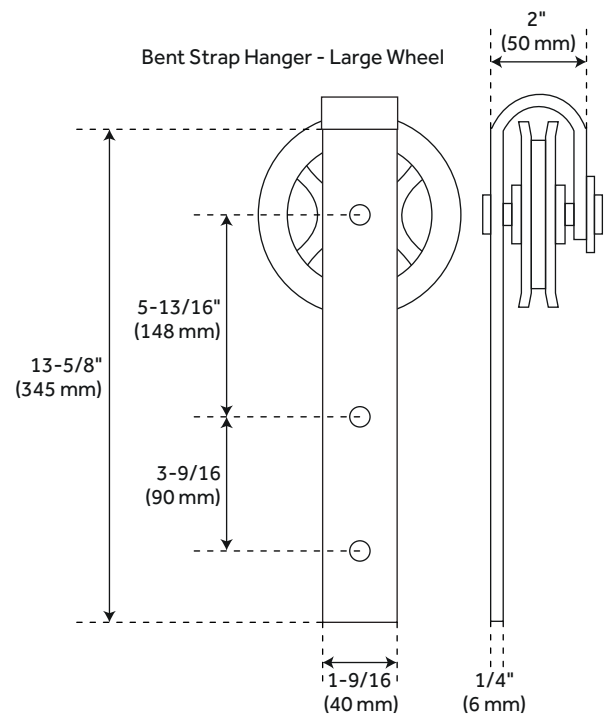
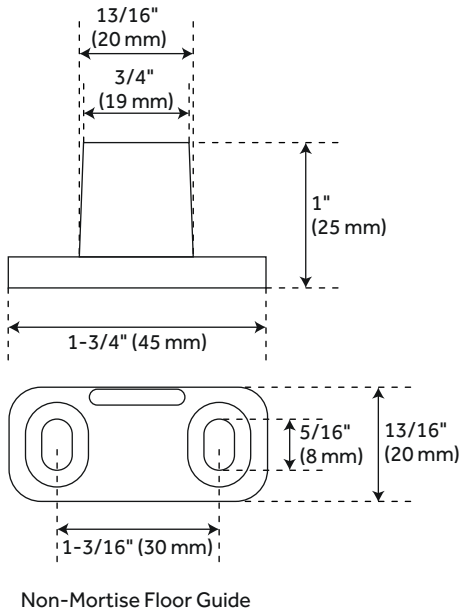
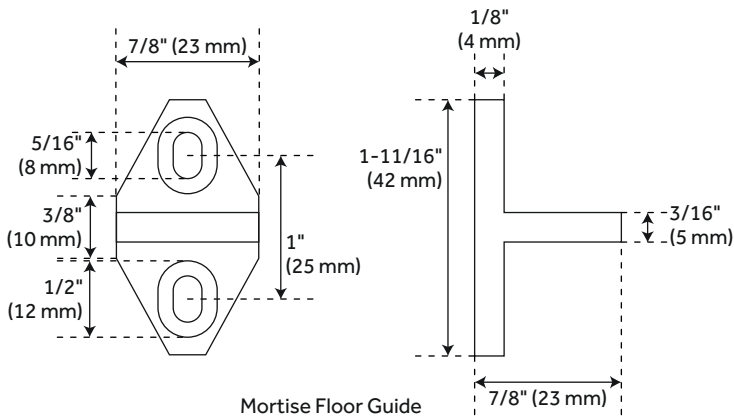

All dimensions and specifications are nominal and may vary. Use actual products for accuracy in critical situations.

# 96" ANDO BARN DOOR HARDWARE KIT

SKU: 950673

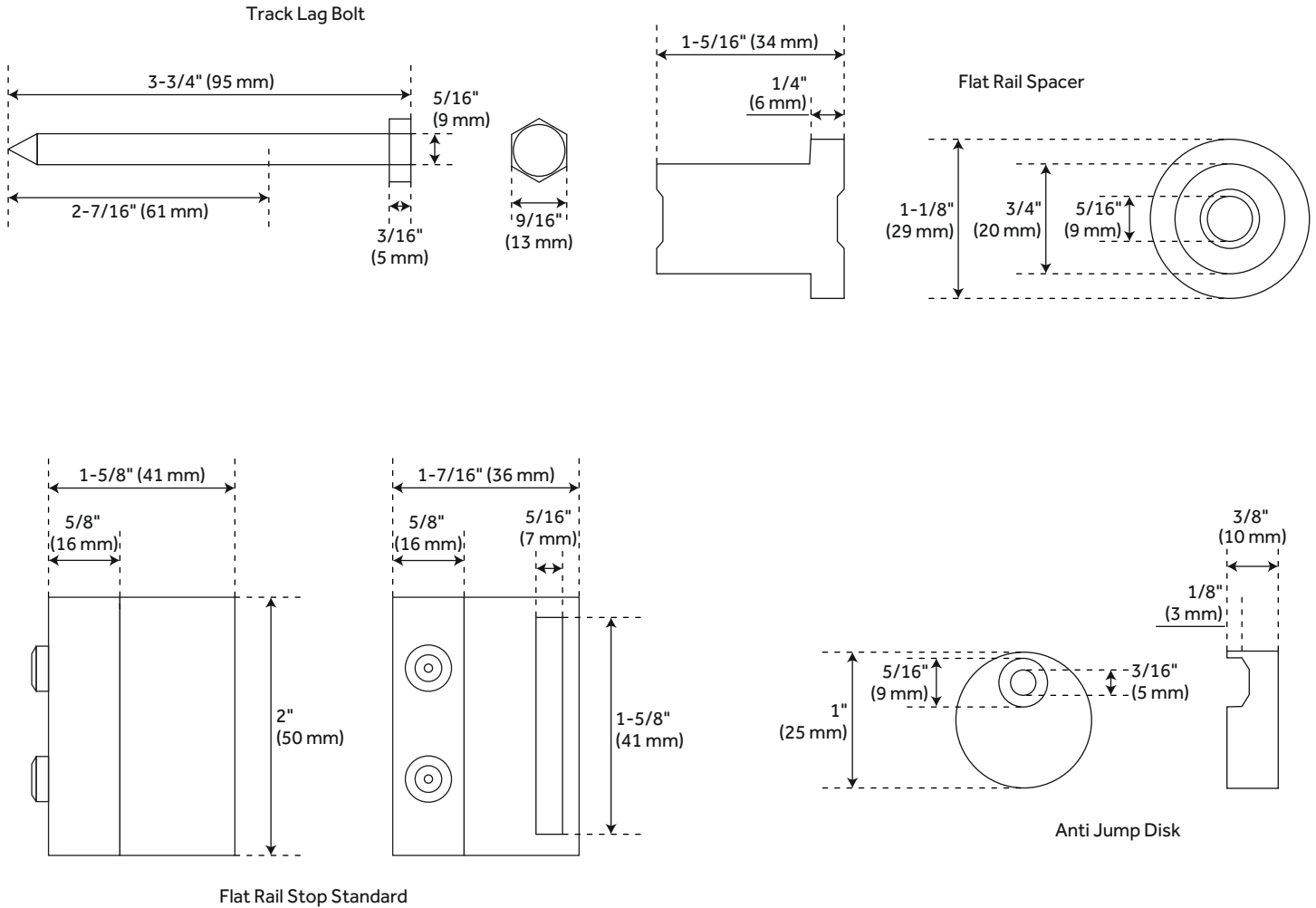

All dimensions and specifications are nominal and may vary. Use actual products for accuracy in critical situations.