

SHOWER CONVERSION KIT

SKU: 953102

BEFORE YOU BEGIN

We recommend consulting a professional if you are unfamiliar with installing plumbing fixtures. Signature Hardware accepts no liability for any damage to the plumbing, floor, walls, tub, or for personal injury during installation.

Observe all local plumbing and building codes.

Unpack and inspect the item for shipping damage. If any damage is found, contact our Customer Relations team at 1-855-715-1800.

ADDITIONAL QUESTIONS?

Still need help? Check out our Help Center at www.signaturehardware.com for product and warranty information, or contact us through live chat or by emailing support@signaturehardware.com.

GETTING STARTED

- Ensure that you have gathered all of the required materials that are needed for the installation.
- For the following instructions, it is assumed that the tub faucet is already in place and prepared for installation of the shower conversion kit

TOOLS AND MATERIALS:



Plumber's Tape*



Phillips Screwdriver*



Thread Sealant*



Adjustable Wrench*



Hex Wrench



Tape Measure



Drill



Level



Hammer

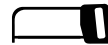

Hacksaw



Pencil



1/4" Drill Bit

Not Included*

REVISED 11/29/2022

SHOWER CONVERSION KIT

SKU: 953102

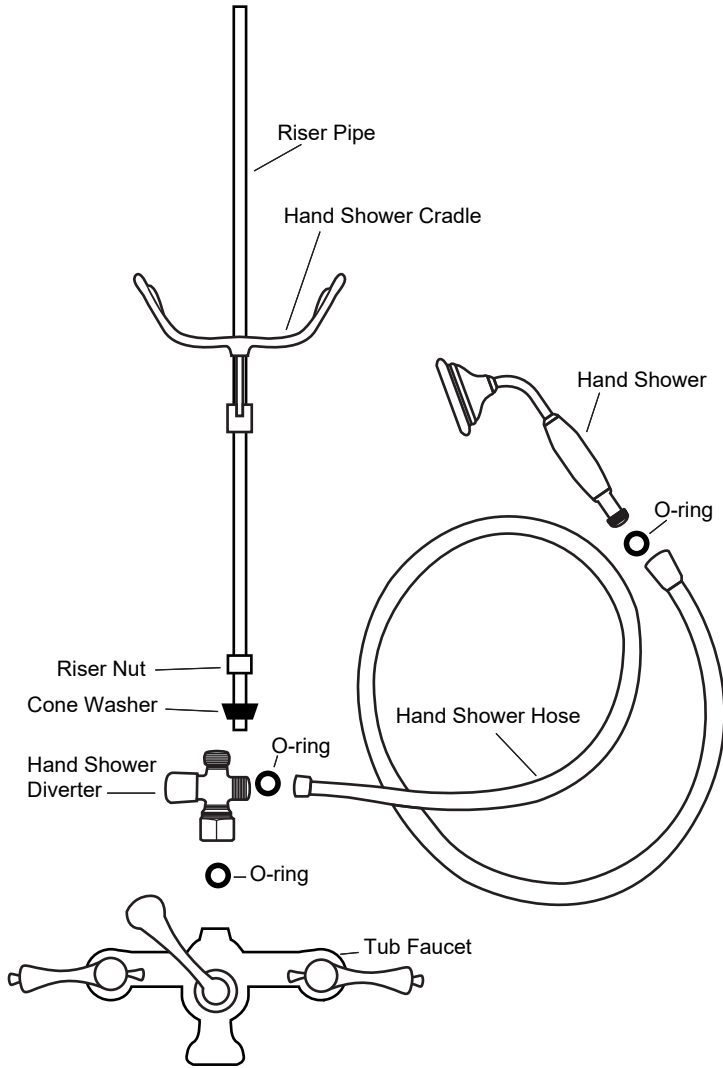

INSTALLATION

1. Insert the provided rubber O-ring into the base of the hand shower diverter, and attach the diverter to the tub faucet as shown. Apply a bit of thread sealant or plumber's tape to the threads before tightening. Use an adjustable wrench to tighten firmly.

Tip: Wrap the nut with a thin wash cloth while tightening to prevent the wrench from scratching the plated finish.

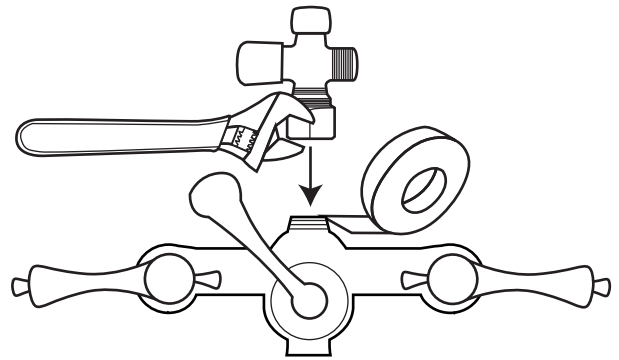

2. Slide the hand shower cradle onto the lower riser pipe. Position the cradle in its desired location, then tighten the set screw on the cradle to secure using the provided hex wrench.

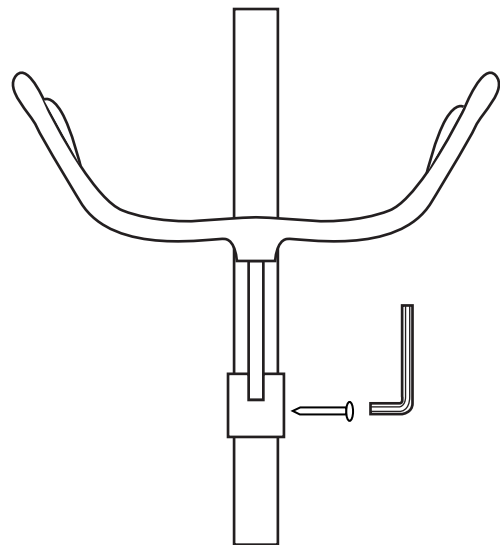

SHOWER CONVERSION KIT

SKU: 953102

3. Slide the riser nut onto the lower riser pipe, with the threaded side facing down. Slide the rubber cone washer onto the lower riser pipe below the riser nut, with the beveled side of the washer facing down as shown.

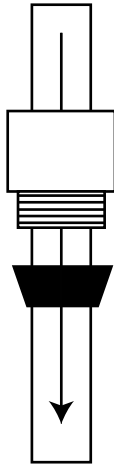

4. Insert the lower riser pipe into the top of the hand shower diverter and secure it by tightening the riser nut. If needed, riser pipe can be cut to size on non-threaded end.

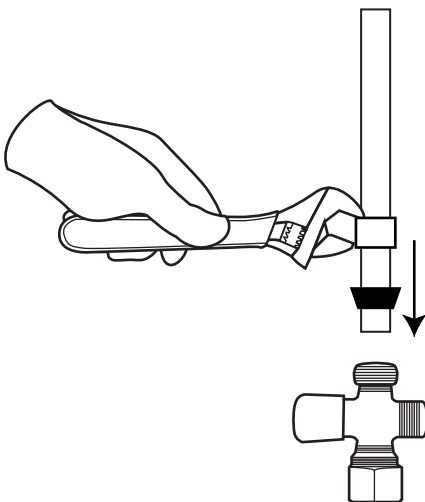

5. Attach the handheld shower head to its handle, then use the provided hose to connect the hand shower to the diverter outlet, as shown. Insert one of the provided rubber O-rings into each end of the hose before tightening.

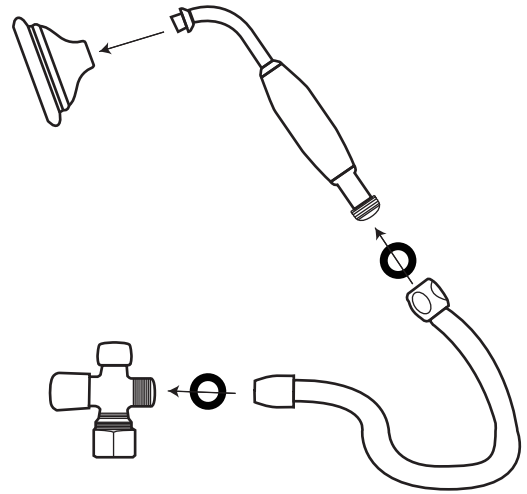

6. Insert the upper riser pipe through the mounting hole located on the shower curtain rod. Attach the upper riser pipe by threading it into the lower riser pipe. Apply a bit of thread sealant or plumber's tape to the threads before tightening.

Tip: If your shower curtain rod does not contain a mounting hole for your riser pipe, secure the riser to the rod using a double-ringlet coupler (sold separately).

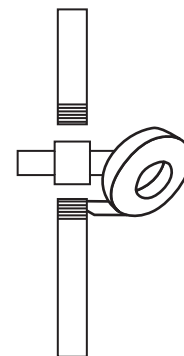

SHOWER CONVERSION KIT

SKU: 953102

7. Complete the installation by installing the shower head onto the upper riser pipe.

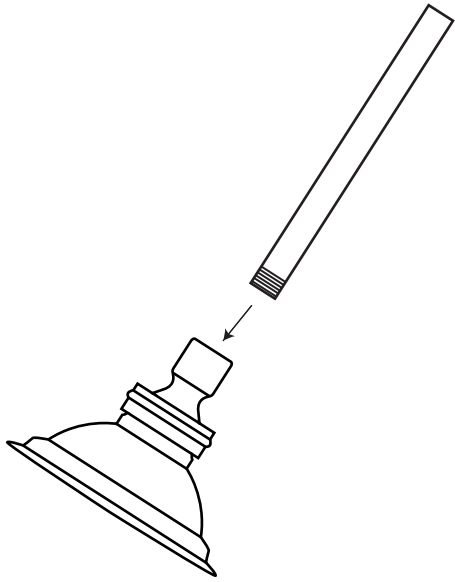

8. Once installation is complete, turn the faucet on and divert water to the shower components. Check to ensure that there are no leaks from any of the connections, and that all functions are working properly.

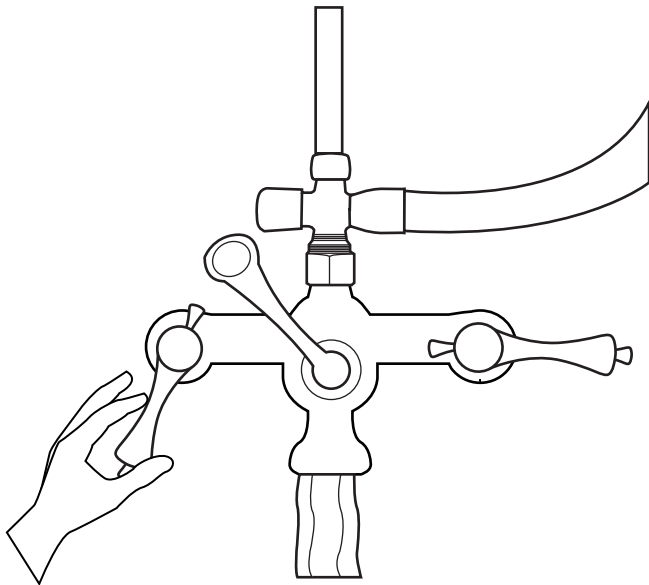

SHOWER CURTAIN INSTALLATION

1. Lay the rod sections on the floor. Assemble the rod with the connector piece.

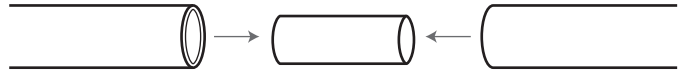

2. Hold the wall brackets up at the desired mounting height.

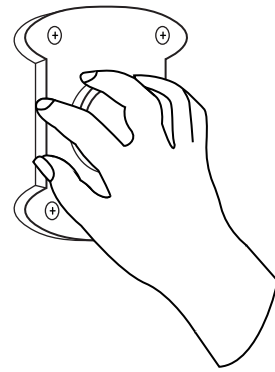

3. Mark the placement of the mounting holes. Use a tape measure and level to make sure that your pencil marks are lined up properly on each wall.

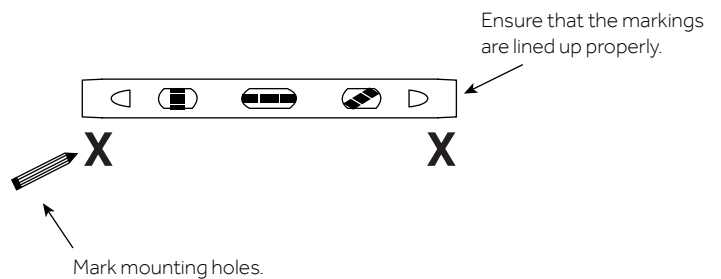

SHOWER CONVERSION KIT

SKU: 953102

4. Drill pilot holes for the wall anchors.

Note: If there is a stud in your mounting location, use wood screws to attach the wall brackets.

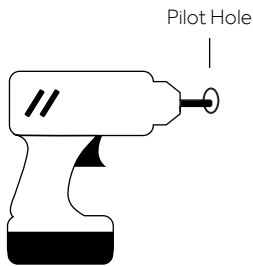

X

5. Gently tap the anchors into the pilot holes with a hammer.

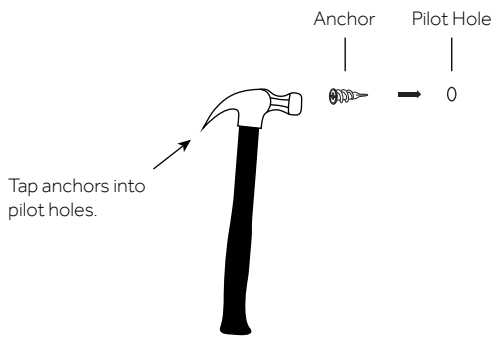

6. Attach the rod and brackets to the wall with the mounting hardware provided.

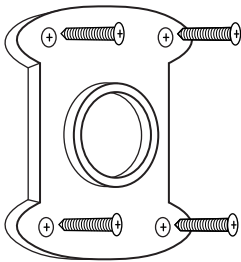

7. Slide the 1" loop onto the curved section of the rod.

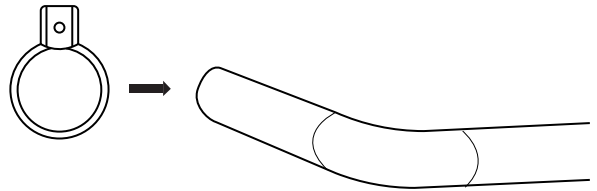

8. Insert the ends of the rod into the wall brackets. Tighten the set screws with a Philips head screwdriver to secure.

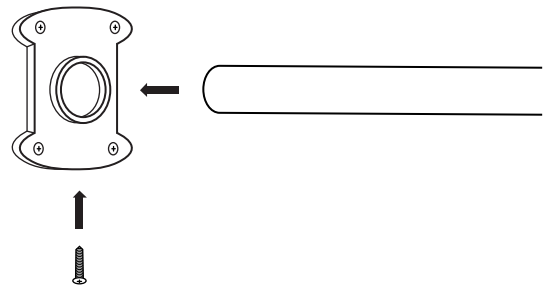

9. Mark the location of the support and measure the distance between it and the rod. If necessary, trim the support to the proper length with your hacksaw.



SHOWER CONVERSION KIT

SKU: 953102

10. Once the support is ready, insert it into the 1" loop. Attach the ceiling bracket to the other end and tighten the set screws.

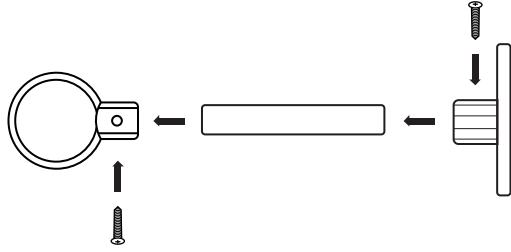

11. Hold the rod support in place and mark the location of the mounting holes.

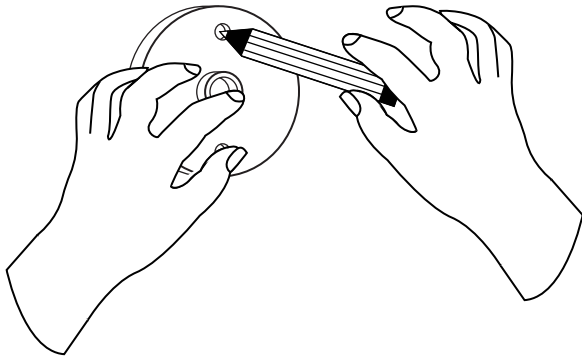

12. Drill pilot holes for the anchors and tap the anchors in with a hammer.

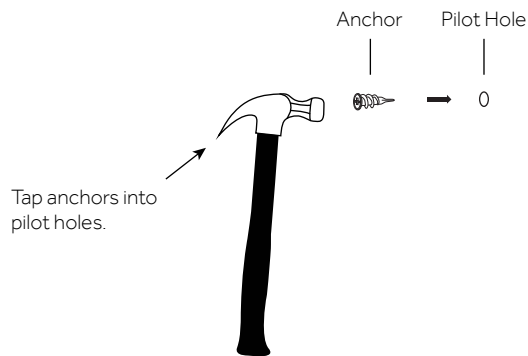

13. Attach the support bracket.

