

LEXIA

THERMOSTATIC SHOWER SYSTEM AND HAND SHOWER
 SISTEMA DE DUCHA TERMOSTÁTICA Y DUCHA DE MANO
 SYSTÈME DE DOUCHE THERMOSTATIQUE ET DOUCHETTE À MAIN

SKU: 953781

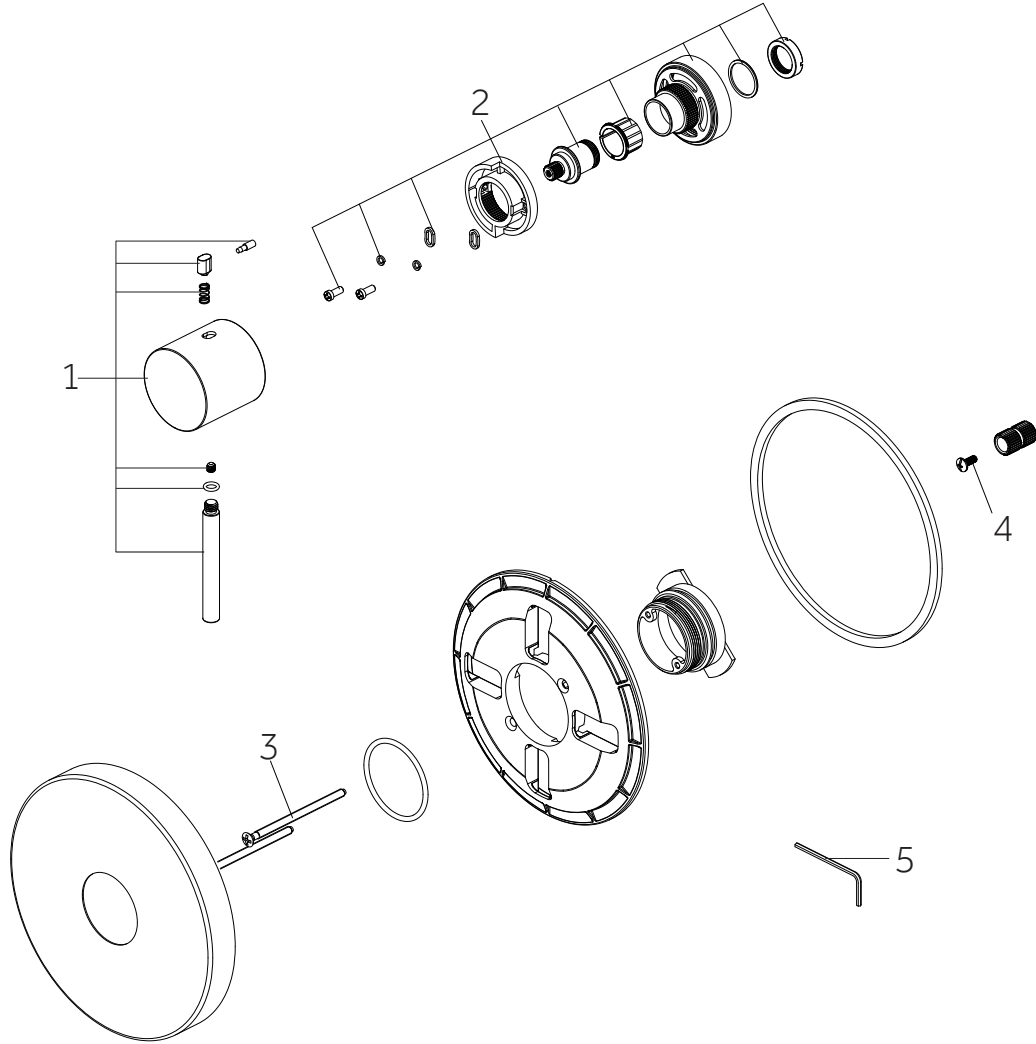

No.	Part Name	Nombre de pieza	Pièce	Part No.
1	Handle Assembly	Ensamblaje de la Manija	Manette	OBPF713069*
2	Handle Seat Assembly	Montaje del asiento del mango	Assemblage du siège de la poignée	OBPF713070*
3	Screw	Tornillo	Vis	OBPF50026CP
4	Screw	Tornillo	Vis	OBPF150142
5	2.5mm Hex Allen Wrench	2.5mm Hex Llave Allen	2.5mm Hex Cié hexagonale	OBPF1RP70221

*Specify Finish / Especifica el Acabado / Spécifiez la Finition

Code: SH9009

LEXIA

THERMOSTATIC SHOWER SYSTEM AND HAND SHOWER
 SISTEMA DE DUCHA TERMOSTÁTICA Y DUCHA DE MANO
 SYSTÈME DE DOUCHE THERMOSTATIQUE ET DOUCHETTE À MAIN

SKU: 953781

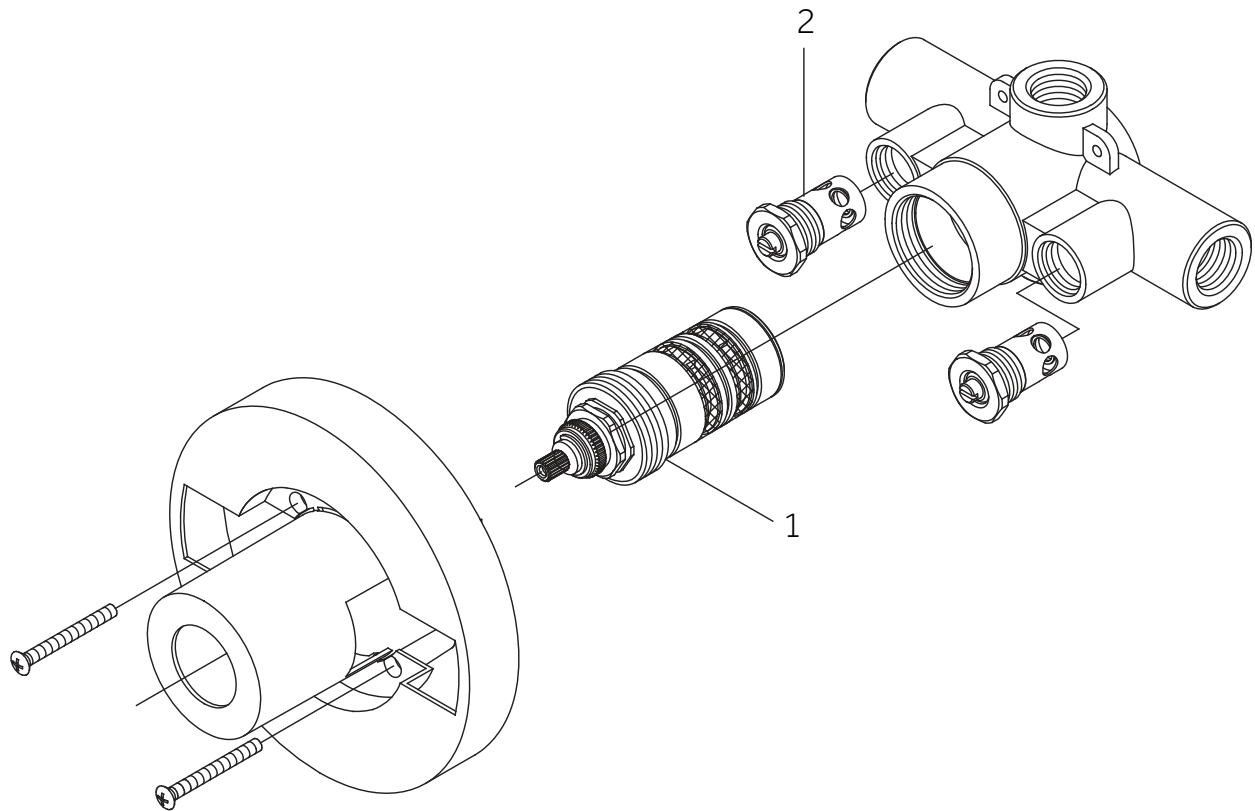

No.	Part Name	Nom de la pièce	Pieza	Part No.
1	1/2" Thermostatic Valve Cartridge 3/4" Thermostatic Valve Cartridge	1/2" Cartucho de válvula termostática 3/4" Cartucho de válvula termostática	1/2" Cartouche de vanne thermostatique 3/4" Cartouche de vanne thermostatique	SH6004CRT SH6006CRT
2	Check valve & stops	Válvula de retención y parada	Clapet anti-retour et arrêt	OBPF3CT1002

Code: SH6006

LEXIA

THERMOSTATIC SHOWER SYSTEM AND HAND SHOWER
SISTEMA DE DUCHA TERMOSTÁTICA Y DUCHA DE MANO
SYSTÈME DE DOUCHE THERMOSTATIQUE ET DOUCHETTE À MAIN

SKU: 953781

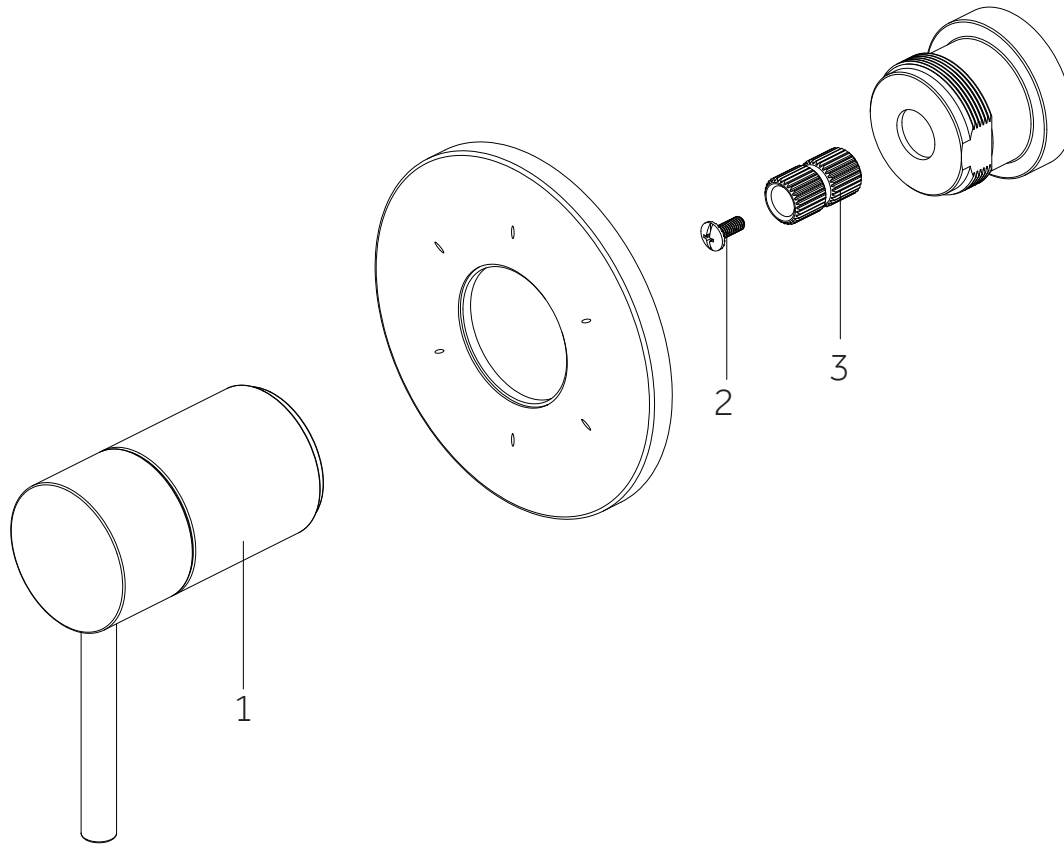

No.	Part Name	Nombre de pieza	Pièce	Part No.
1	Handle Assembly	Ensamblaje de la Manija	Manette	OBPF713071*
2	Screw	Tornillo	Vis	OBPF150142
3	Connector	Conector	Raccorder	OBPF870350

*Specify Finish / Especifica el Acabado / Spécifiez la Finition

Code: SHLE9005

LEXIA

THERMOSTATIC SHOWER SYSTEM AND HAND SHOWER
SISTEMA DE DUCHA TERMOSTÁTICA Y DUCHA DE MANO
SYSTÈME DE DOUCHE THERMOSTATIQUE ET DOUCHETTE À MAIN

SKU: 953781

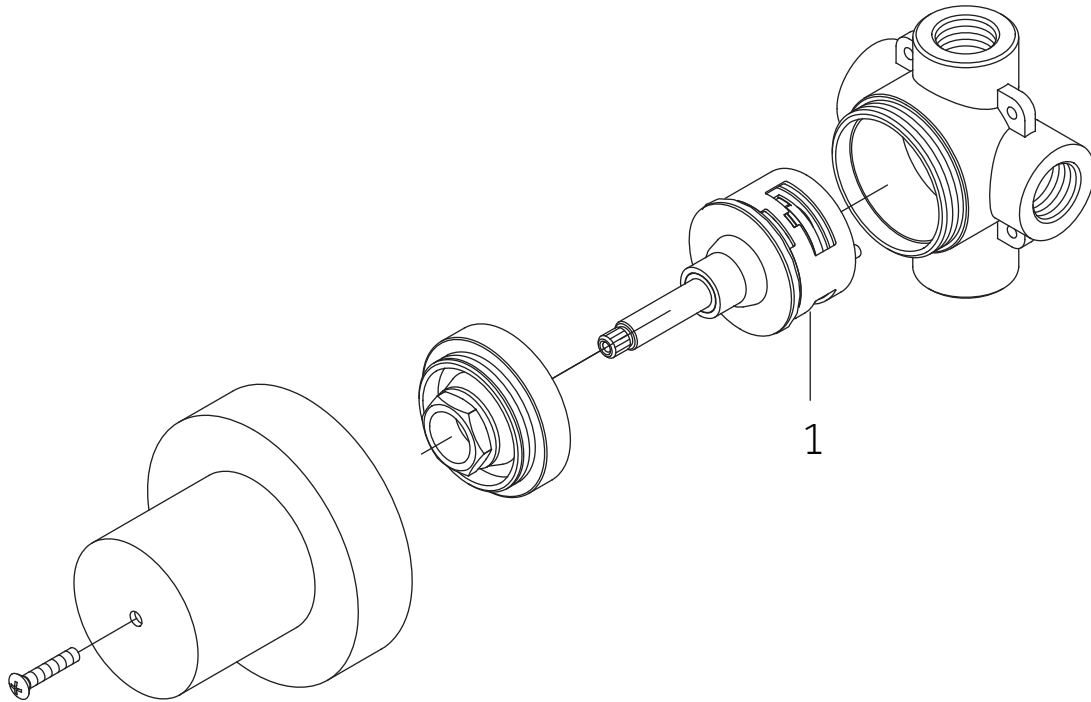

No.	Part Name	Nom de la pièce	Pieza	Part No.
1	6 Way Cartridge	Cartucho de 6 vías	Cartouche 6 Voies	SH6180

Code: SH6103

LEXIA

THERMOSTATIC SHOWER SYSTEM AND HAND SHOWER
SISTEMA DE DUCHA TERMOSTÁTICA Y DUCHA DE MANO
SYSTÈME DE DOUCHE THERMOSTATIQUE ET DOUCHETTE À MAIN

SKU: 953781

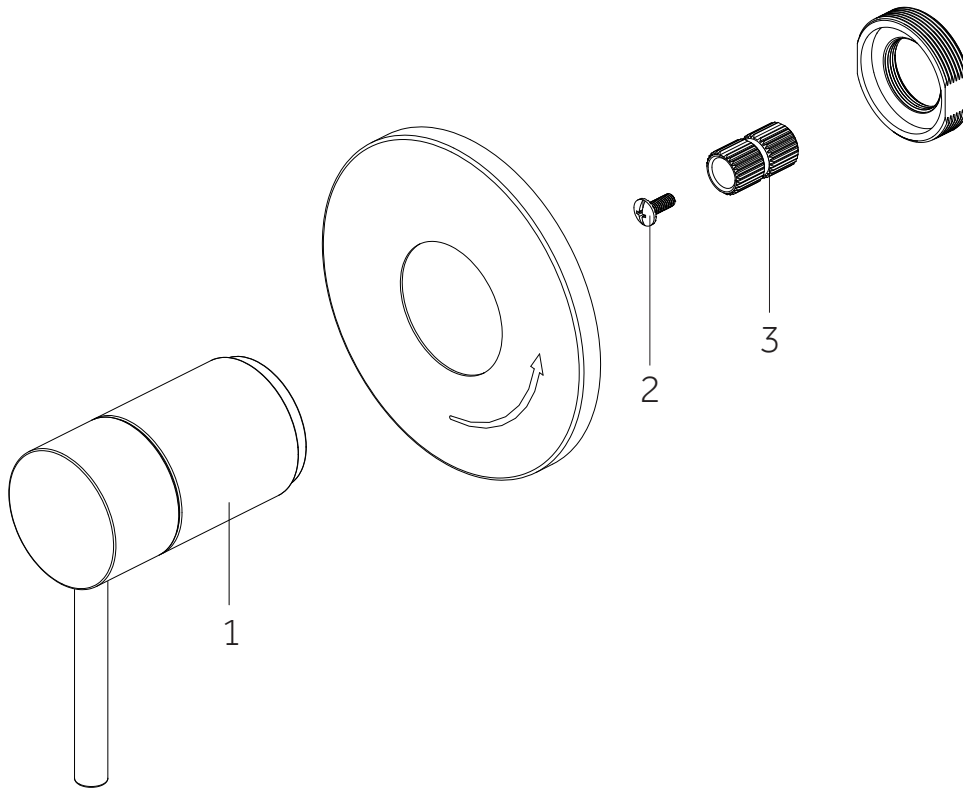

No.	Part Name	Nombre de pieza	Pièce	Part No.
1	Handle Assembly	Ensamblaje de la Manija	Manette	OBPF713071*
2	Screw	Tornillo	Vis	OBPF150142
3	Connector	Conector	Raccorder	OBPF870350

*Specify Finish / Especifica el Acabado / Spécifiez la Finition

Code: SH9007

LEXIA

THERMOSTATIC SHOWER SYSTEM AND HAND SHOWER
 SISTEMA DE DUCHA TERMOSTÁTICA Y DUCHA DE MANO
 SYSTÈME DE DOUCHE THERMOSTATIQUE ET DOUCHETTE À MAIN

SKU: 953781

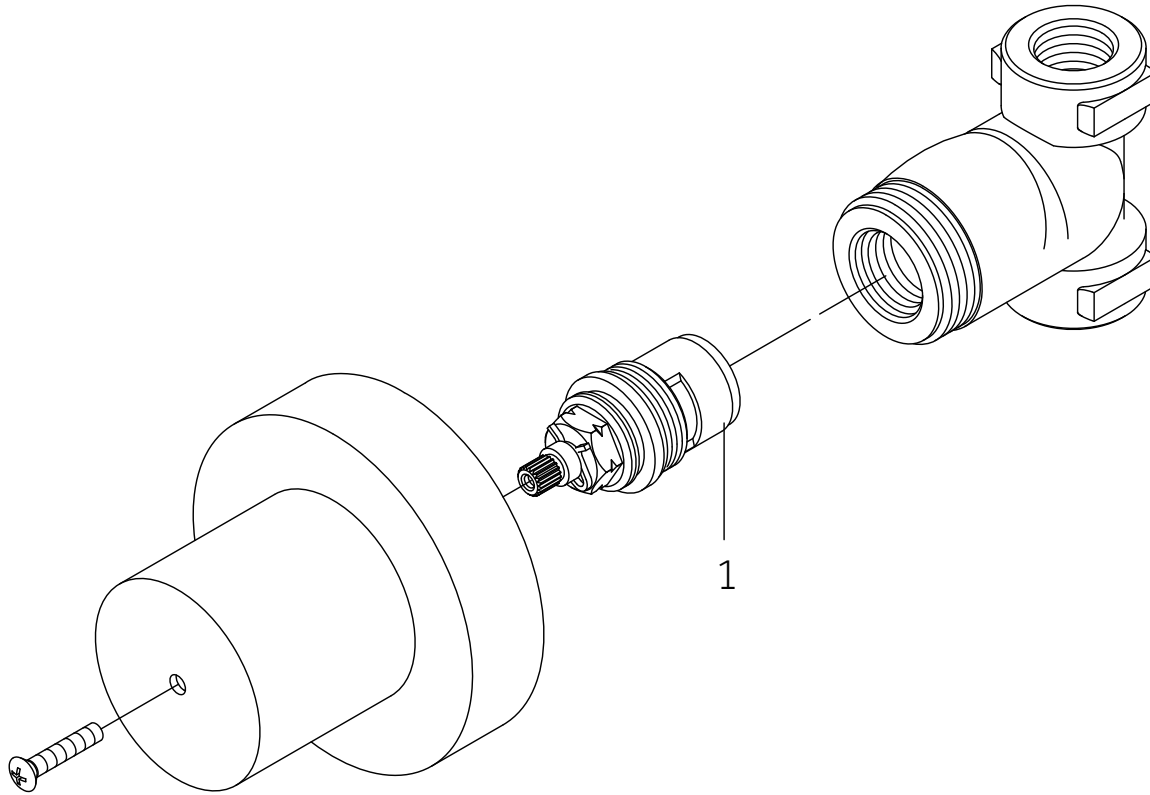

NO.	Part Name	Nombre de pieza	Pièce	Part No.
1	1/2" VOLUME CONTROL VALVE CARTRIDGE 3/4" VOLUME CONTROL VALVE CARTRIDGE	CARTUCHO DE VALVULA DE CONTROL DE VOLUMEN DE 1/2 CARTUCHO DE VALVULA DE CONTROL DE VOLUMEN DE 3/4	VALVE DE CONTRÔLE DE VOLUME 1/2" VALVE DE CONTRÔLE DE VOLUME 3/4"	SH6020CRT SH6040CRT

Code: SH6040