

# BEASLEY

THERMOSTATIC SHOWER SYSTEM AND HAND SHOWER  
 SISTEMA DE DUCHA TERMOSTÁTICA Y DUCHA DE MANO  
 SYSTÈME DE DOUCHE THERMOSTATIQUE ET DOUCHETTE À MAIN  
 SKU: 953962

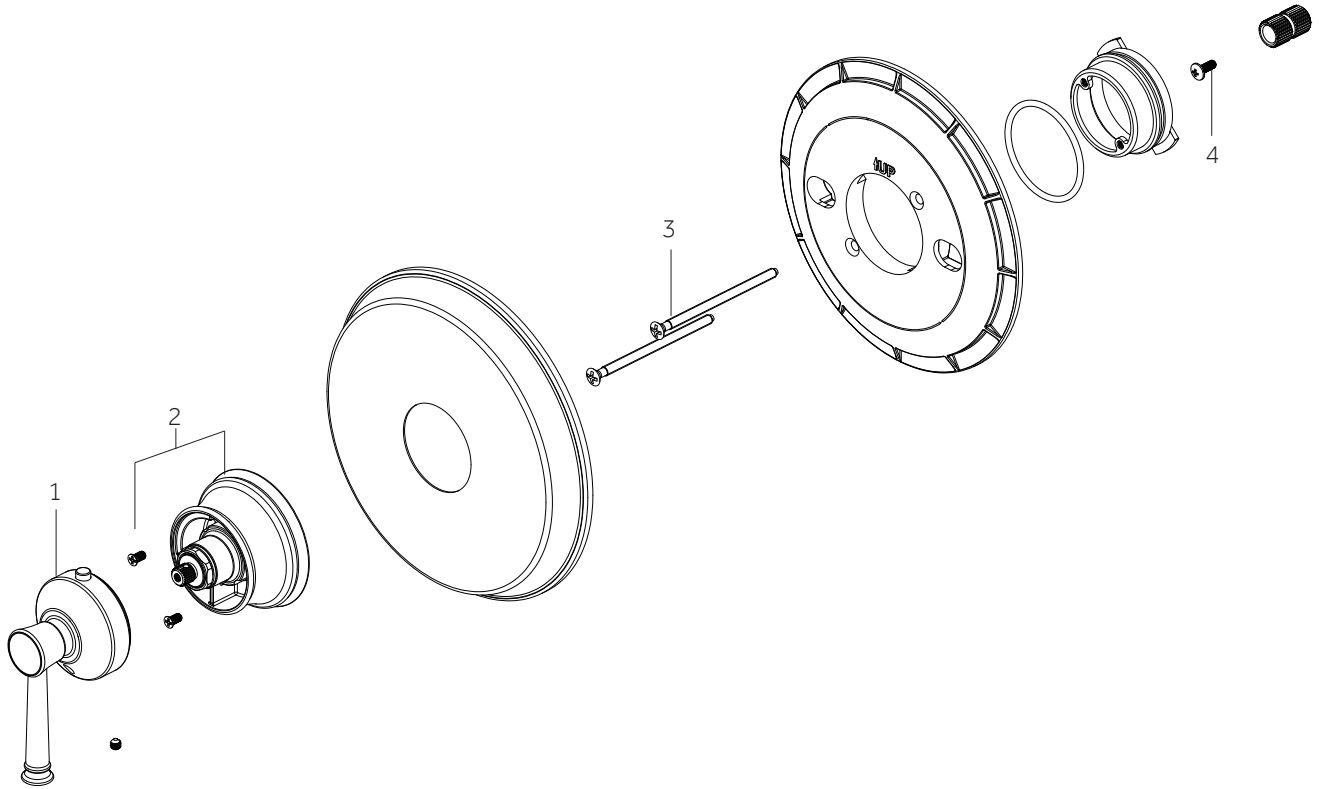

No.	Part Name	Nombre de pieza	Pièce	Part No.
1	Handle	Llave	Poignée	OBPF7F13015*
2	Handle	Llave	Poignée	OBPF7F13017*
3	Screw	Tornillo	Vis	OBPF50026*
4	Screw	Tornillo	Vis	OBPF150142

\*Specify Finish / Especifica el Acabado / Spécifiez la Finition

Code: SHBE9009

# BEASLEY

THERMOSTATIC SHOWER SYSTEM AND HAND SHOWER  
 SISTEMA DE DUCHA TERMOSTÁTICA Y DUCHA DE MANO  
 SYSTÈME DE DOUCHE THERMOSTATIQUE ET DOUCHETTE À MAIN  
 SKU: 953962

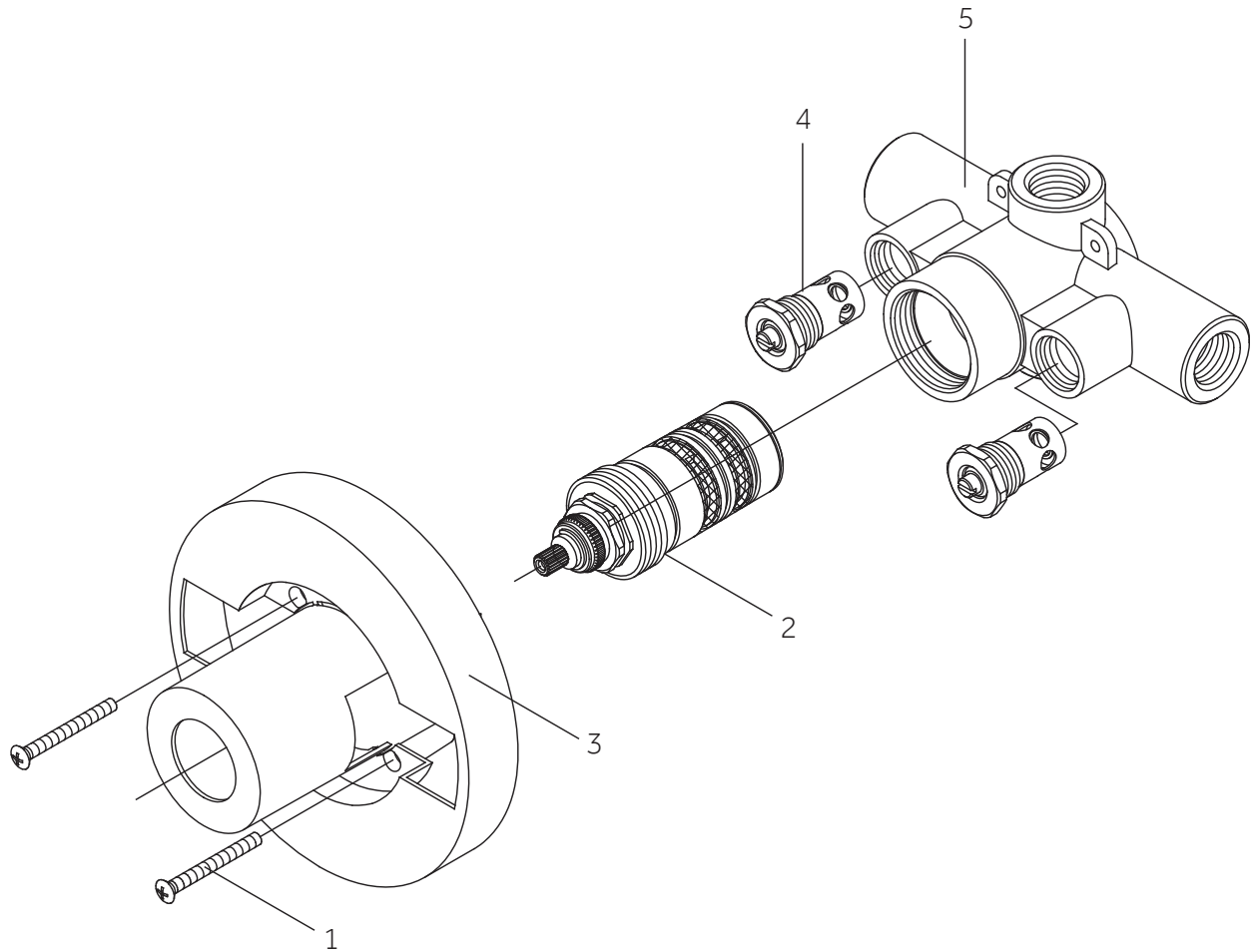

No.	Part Name	Nombre de pieza	Nom de la pièce
1	Screw	Tornillo	Vis
2	MIR6004CRT 1/2" Cartridge MIR6006CRT 3/4" Cartridge	MIR6004CRT 1/2" Cartucho MIR6006CRT 3/4" Cartucho	MIR6004CRT 1/2" Cartouche MIR6006CRT 3/4" Cartouche
3	Cover	Cubrir	Couverture
4	Check Valve & Stops	Válvula de retención y paradas	Clapet anti-retour et arrêts
5	Body	Cuerpo	Corps

\*Specify Finish / Especifica el Acabado / Spécifiez la Finition

Code: SH6004, SH6006

# BEASLEY

THERMOSTATIC SHOWER SYSTEM AND HAND SHOWER  
SISTEMA DE DUCHA TERMOSTÁTICA Y DUCHA DE MANO  
SYSTÈME DE DOUCHE THERMOSTATIQUE ET DOUCHETTE À MAIN  
SKU: 953962

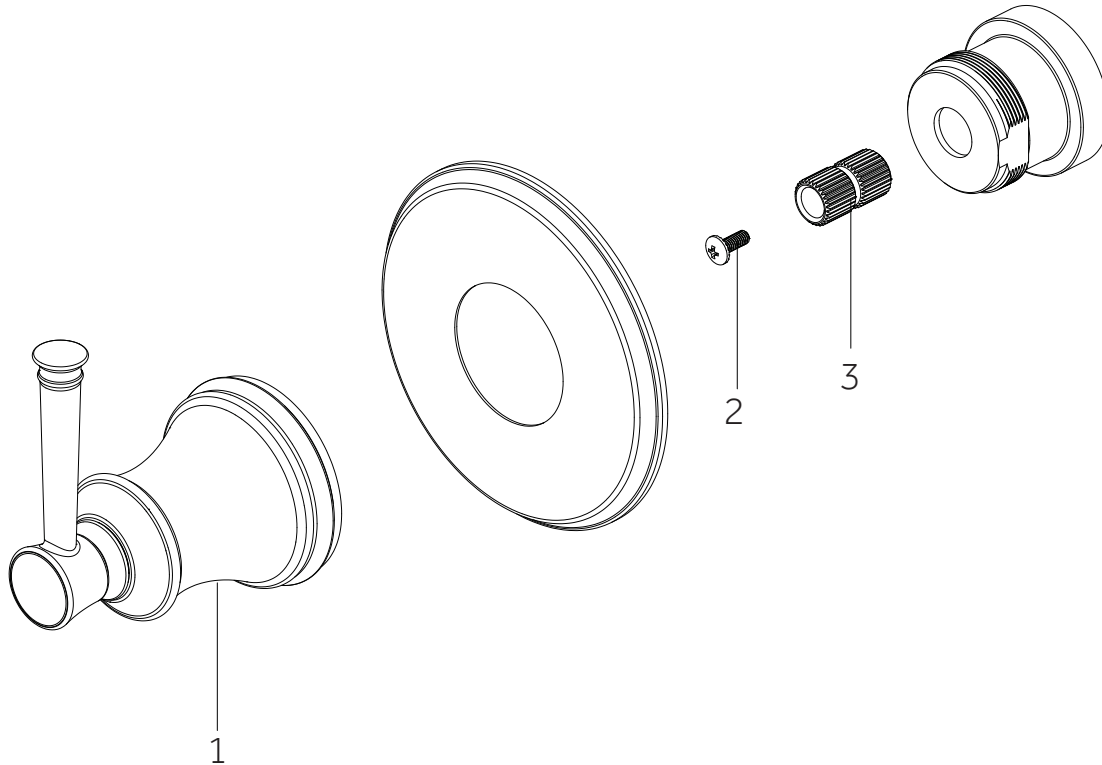

No.	Part Name / Nombre de pieza / Pièce	Part No.
1	Handle Assembly / Ensamblaje de la Manija / Manette	OBPF7F13016*
2	Screw / Tornillo / Vis	OBPF150142
3	Connector / Conector / Raccorder	OBPF870350

\*Specify Finish / Especifica el Acabado / Spécifiez la Finition

Code: SHBE90052

# BEASLEY

THERMOSTATIC SHOWER SYSTEM AND HAND SHOWER  
 SISTEMA DE DUCHA TERMOSTÁTICA Y DUCHA DE MANO  
 SYSTÈME DE DOUCHE THERMOSTATIQUE ET DOUCHETTE À MAIN  
 SKU: 953962

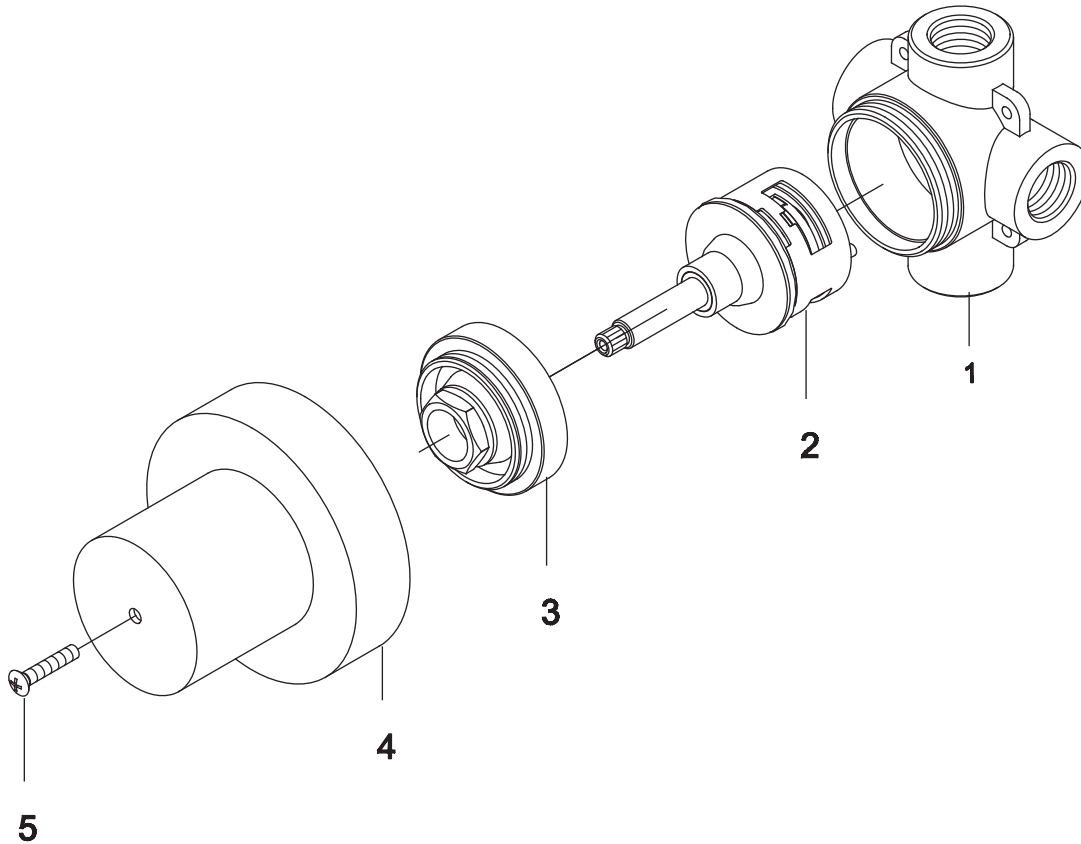

No.	Part Name	Nombre de pieza	Nom de la pièce
1	Body	Cuerpo	Corps
2	6 way cartridge: MIR6180 CALGreen cartridge (no shared positions): MIR6150	Cartucho de 6 vías: MIR6180 Cartucho CALGreen (sin posiciones compartidas): MIR6150	Cartouche 6 voies: MIR6180 Cartouche CALGreen (pas de positions partagées): MIR6150
3	Hub	Cubo	Centre
4	Cover	Cubrir	Couverture
5	Screw	Tornillo	Vis

\*Specify Finish / Especifica el Acabado / Spécifiez la Finition

Code: SH6103, SH6101

# BEASLEY

THERMOSTATIC SHOWER SYSTEM AND HAND SHOWER  
SISTEMA DE DUCHA TERMOSTÁTICA Y DUCHA DE MANO  
SYSTÈME DE DOUCHE THERMOSTATIQUE ET DOUCHETTE À MAIN  
SKU: 953962

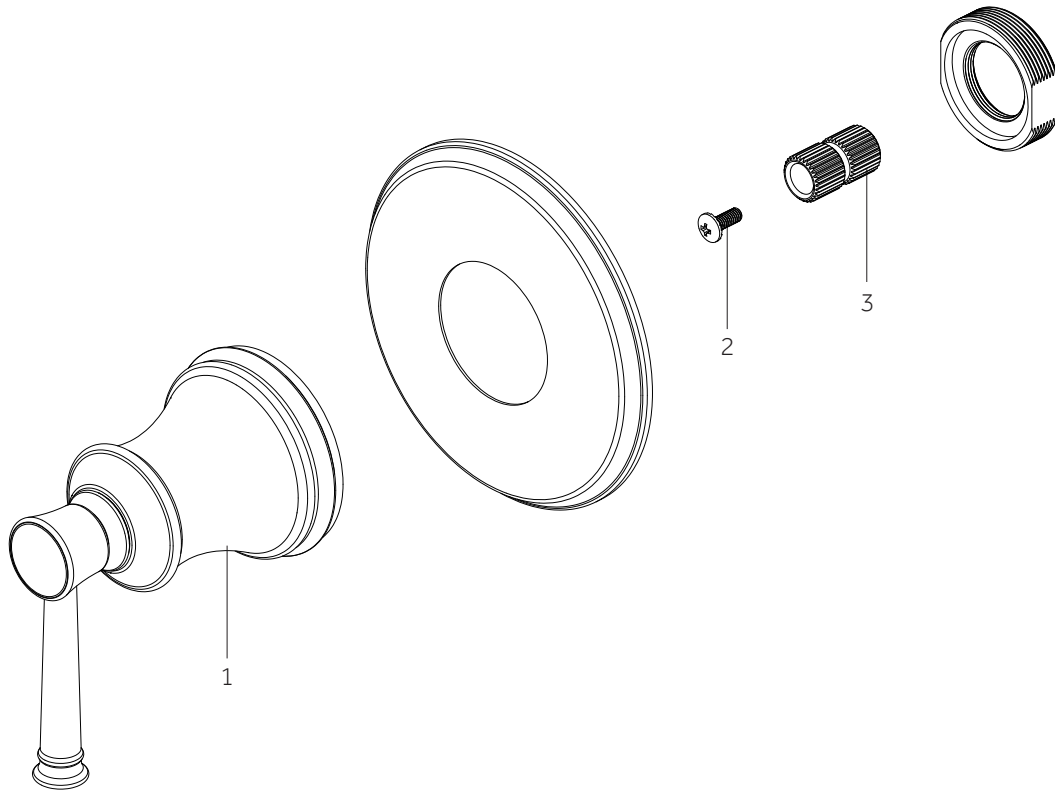

No.	Part Name	Nombre de pieza	Pièce	Part No.
1	Handle	Llave	Poignée	OBPF7F13016*
2	Screw	Tornillo	Vis	OBPF150142
3	Connector	Conector	Raccorder	OBPF870350

\*Specify Finish / Especifica el Acabado / Spécifiez la Finition

Code: SHBE9007

# BEASLEY

THERMOSTATIC SHOWER SYSTEM AND HAND SHOWER  
 SISTEMA DE DUCHA TERMOSTÁTICA Y DUCHA DE MANO  
 SYSTÈME DE DOUCHE THERMOSTATIQUE ET DOUCHETTE À MAIN  
 SKU: 953962

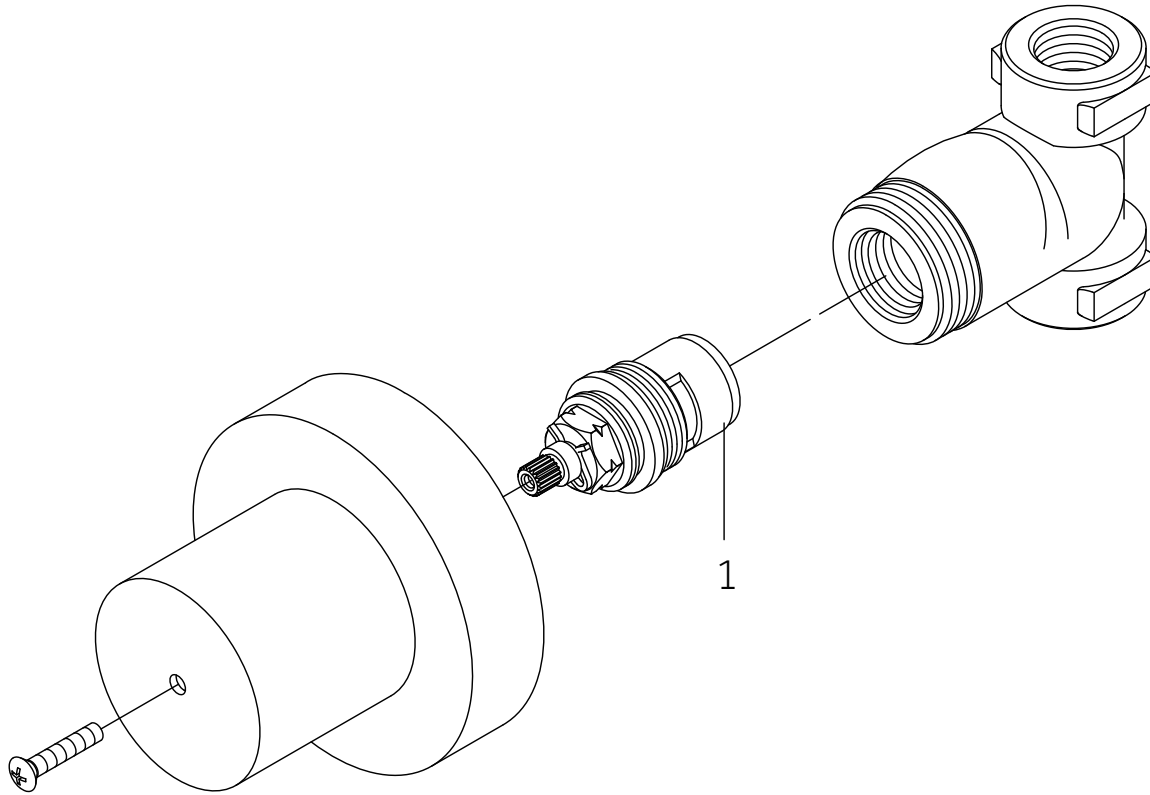

NO.	Part Name	Nombre de pieza	Pièce	Part No.
1	1/2" VOLUME CONTROL VALVE CARTRIDGE 3/4" VOLUME CONTROL VALVE CARTRIDGE	CARTUCHO DE VALVULA DE CONTROL DE VOLUMEN DE 1/2 CARTUCHO DE VALVULA DE CONTROL DE VOLUMEN DE 3/4	VALVE DE CONTRÔLE DE VOLUME 1/2" VALVE DE CONTRÔLE DE VOLUME 3/4"	SH6020CRT SH6040CRT

\*Specify Finish / Especifica el Acabado / Spécifiez la Finition

Code: SH6020, SH6040