

GREYFIELD

THERMOSTATIC SHOWER SYSTEM AND HAND SHOWER
 SISTEMA DE DUCHA TERMOSTÁTICA Y DUCHA DE MANO
 SYSTÈME DE DOUCHE THERMOSTATIQUE ET DOUCHETTE À MAIN
 SKU: 953974

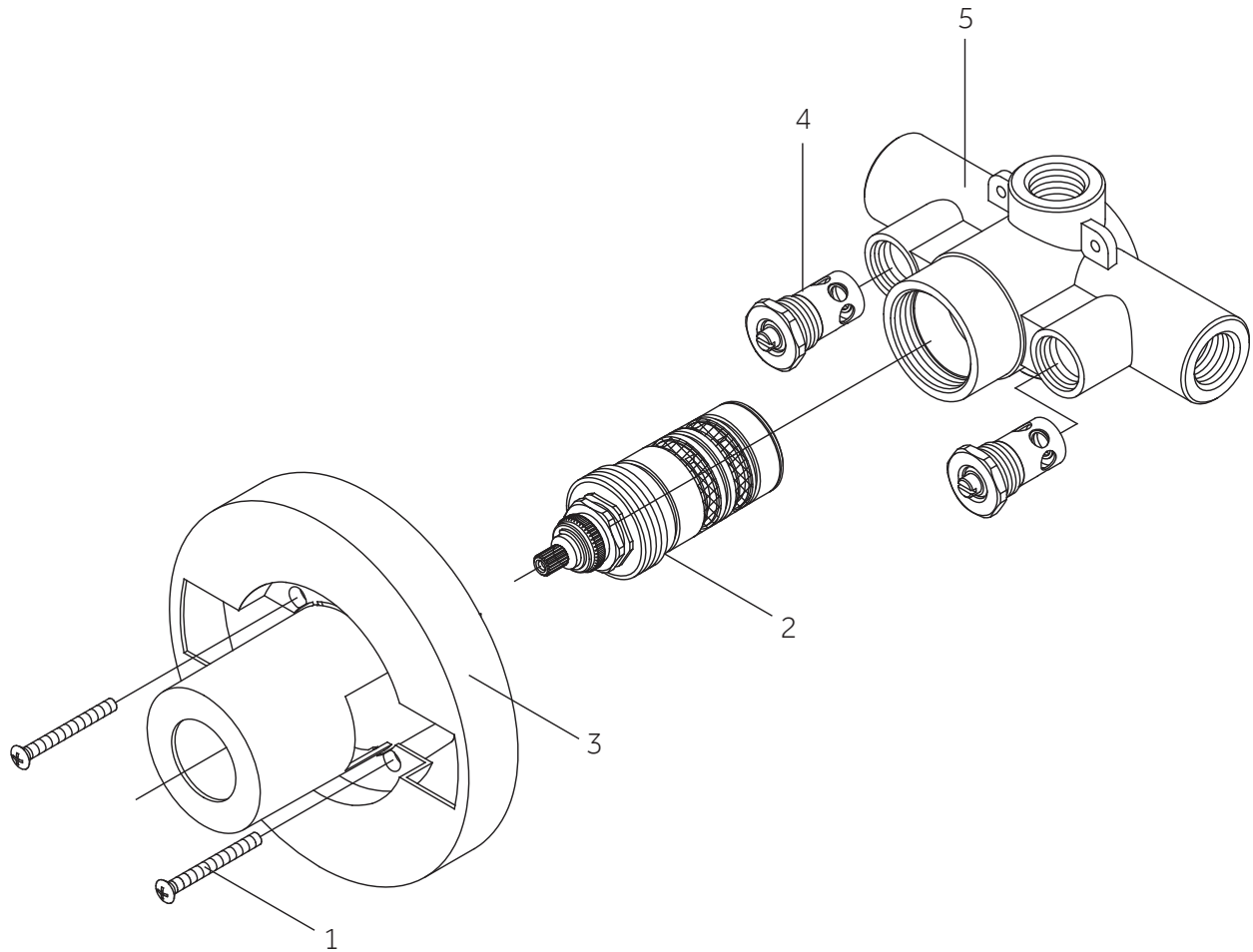

No.	Part Name	Nombre de pieza	Nom de la pièce
1	Screw	Tornillo	Vis
2	MIR6004CRT 1/2" Cartridge MIR6006CRT 3/4" Cartridge	MIR6004CRT 1/2" Cartucho MIR6006CRT 3/4" Cartucho	MIR6004CRT 1/2" Cartouche MIR6006CRT 3/4" Cartouche
3	Cover	Cubrir	Couverture
4	Check Valve & Stops	Válvula de retención y paradas	Clapet anti-retour et arrêts
5	Body	Cuerpo	Corps

*Specify Finish / Especifica el Acabado / Spécifiez la Finition

Code: SH6004, SH6006

GREYFIELD

THERMOSTATIC SHOWER SYSTEM AND HAND SHOWER
 SISTEMA DE DUCHA TERMOSTÁTICA Y DUCHA DE MANO
 SYSTÈME DE DOUCHE THERMOSTATIQUE ET DOUCHETTE À MAIN
 SKU: 953974

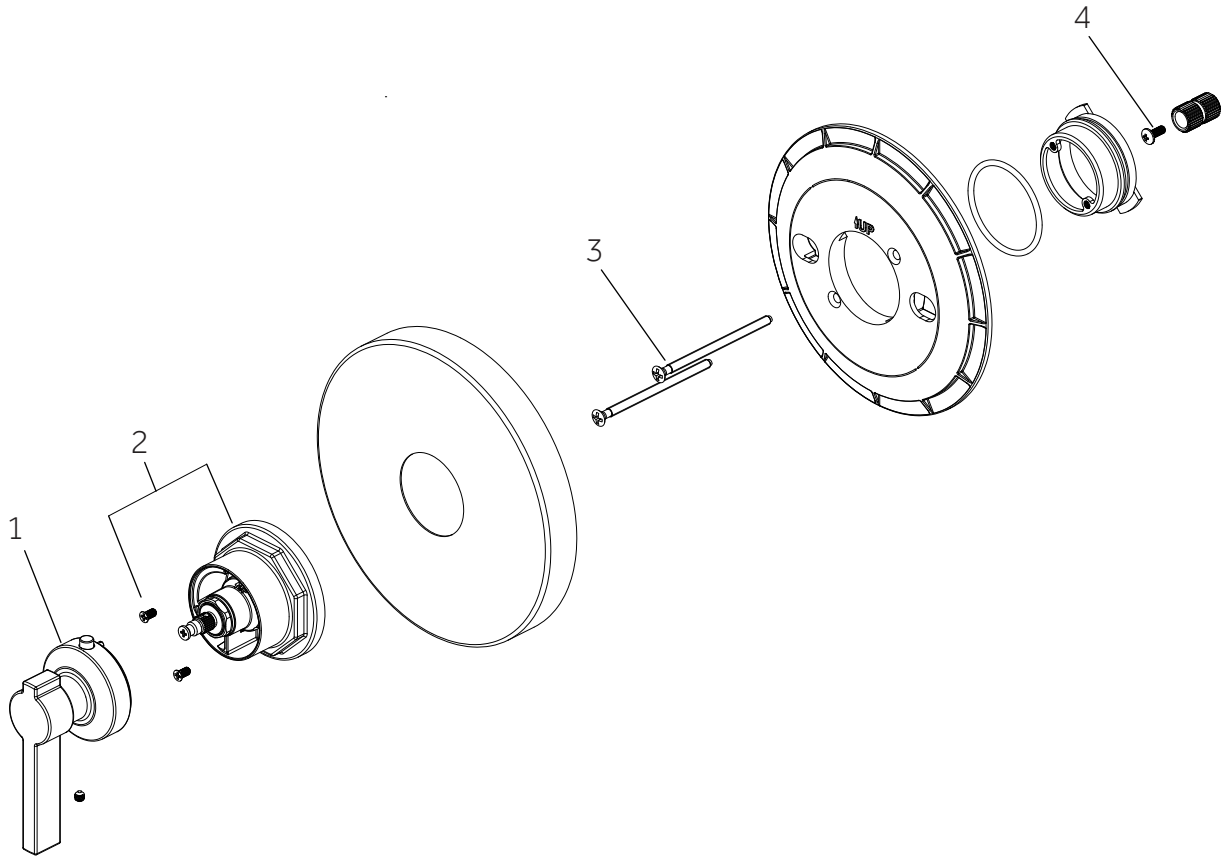

No.	Part Name	Nombre de pieza	Pièce	Part No.
1	Handle	Llave	Poignée	OBPF7F13022*
2	Handle Seat	Asiento de la manija	Poignée Siège	OBPF7F13023*
3	Screw	Tornillo	Vis	OBPF50026CP
4	Screw	Tornillo	Vis	OBPF150142

*Specify Finish / Especifica el Acabado / Spécifiez la Finition

Code: SHGF9009

GREYFIELD

THERMOSTATIC SHOWER SYSTEM AND HAND SHOWER
SISTEMA DE DUCHA TERMOSTÁTICA Y DUCHA DE MANO
SYSTÈME DE DOUCHE THERMOSTATIQUE ET DOUCHETTE À MAIN
SKU: 953974

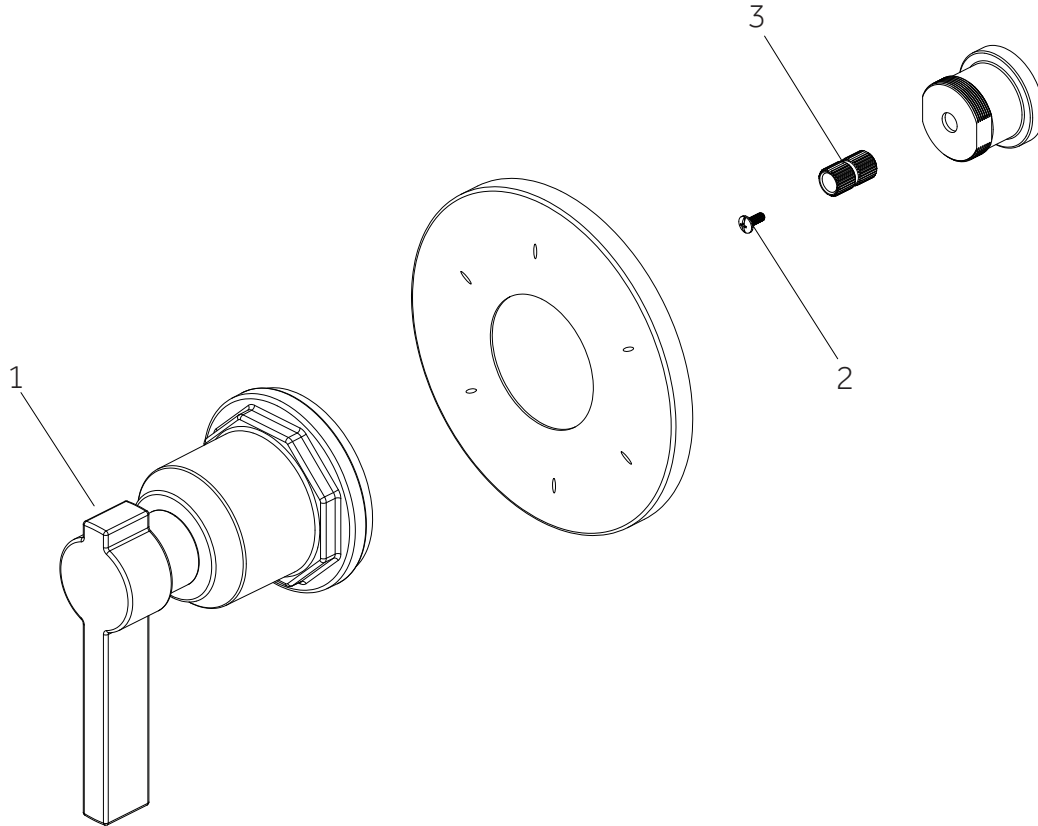

No.	Part Name	Nombre de pieza	Pièce	Part No.
1	Handle	Llave	Poignée	OBPF713679*
2	Screw	Tornillo	Vis	OBPF150142
3	Connector	Conector	Raccorder	OBPF870350

*Specify Finish / Especifica el Acabado / Spécifiez la Finition

Code: SHGF9005

GREYFIELD

THERMOSTATIC SHOWER SYSTEM AND HAND SHOWER
 SISTEMA DE DUCHA TERMOSTÁTICA Y DUCHA DE MANO
 SYSTÈME DE DOUCHE THERMOSTATIQUE ET DOUCHETTE À MAIN
 SKU: 953974

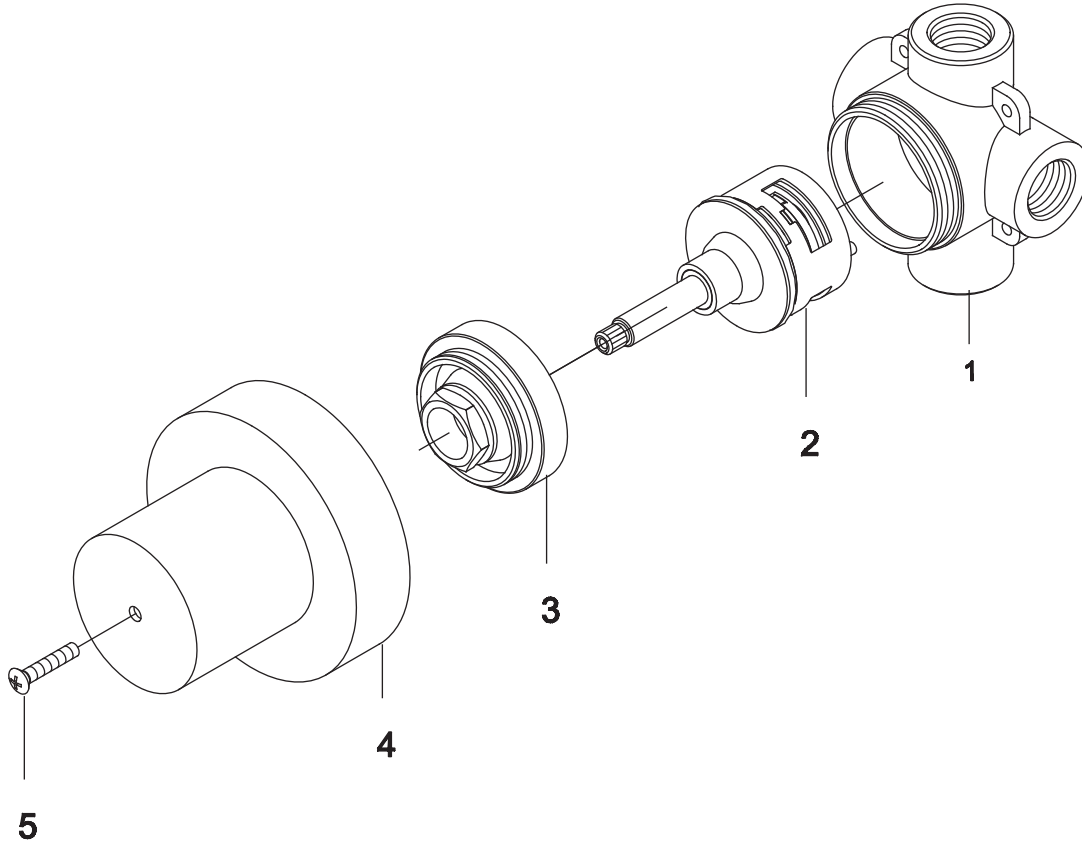

No.	Part Name	Nombre de pieza	Nom de la pièce
1	Body	Cuerpo	Corps
2	6 way cartridge: MIR6180 CALGreen cartridge (no shared positions): MIR6150	Cartucho de 6 vías: MIR6180 Cartucho CALGreen (sin posiciones compartidas): MIR6150	Cartouche 6 voies: MIR6180 Cartouche CALGreen (pas de positions partagées): MIR6150
3	Hub	Cubo	Centre
4	Cover	Cubrir	Couverture
5	Screw	Tornillo	Vis

*Specify Finish / Especifica el Acabado / Spécifiez la Finition

Code: SH6103, SH6101