



COPPER DROP-IN/UNDERMOUNT SINK

BEFORE YOU BEGIN

We recommend consulting a professional if you are unfamiliar with installing bathroom fixtures and plumbing. Signature Hardware accepts no liability for any damage to the floor, walls, plumbing, vanity cabinet, sink, counter top, or personal injury during installation.

Observe all local plumbing and building codes.

Unpack and inspect the sink for damage. If any damage is found, contact our Customer Relations team at 1-855-715-1800.

GETTING STARTED

- Ensure that you have gathered all the required materials that are needed for the installation.
- For the following instructions, it is assumed that the vanity is in place, and the countertop has not yet been installed.

TOOLS AND MATERIALS:



Silicone Sealant
(100% Neutral
Cure)



Damp Cloth



Pencil



COPPER DROP-IN/UNDERMOUNT SINK

Drop-In Installation

1. Install your counter top onto your vanity cabinet. Refer to the counter top's installation instructions for guidance.

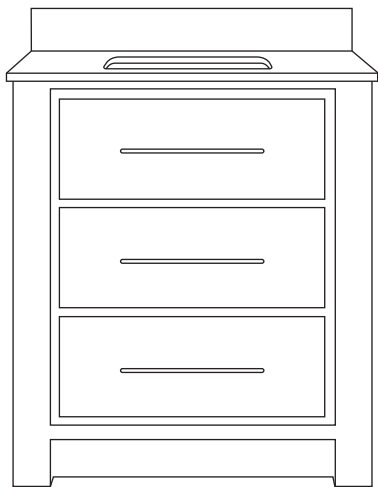

2. Lower the sink into the cutout on the counter to confirm the sink will fit properly. The rim of the sink should sit flat on the counter top.

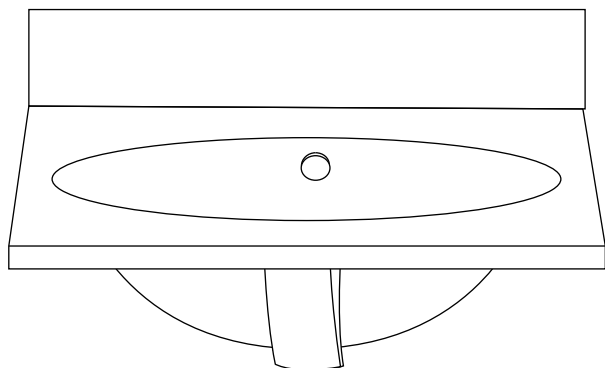

3. Remove the sink and run a bead of neutral cure silicone sealant around the underside of the rim.

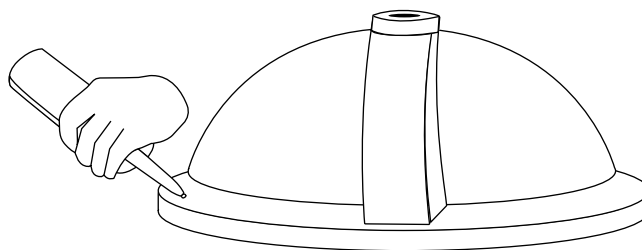

4. Carefully lower the sink back into the cutout and press the sink firmly into place. Wipe away any excess sealant with a damp cloth.

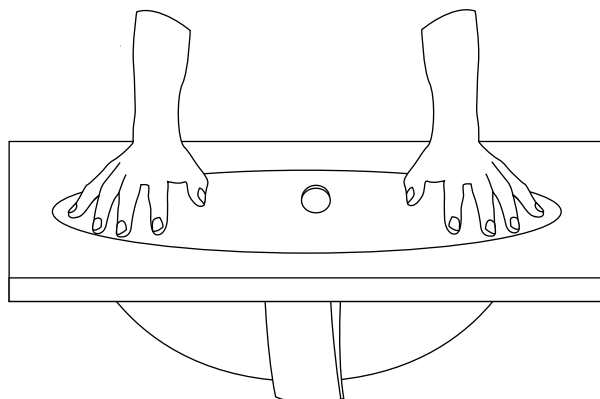



COPPER DROP-IN/UNDERMOUNT SINK

5. Apply a thin bead of silicone sealant around the perimeter of the sink, where the sink meets the counter top. This will prevent moisture from getting underneath the rim of the sink.

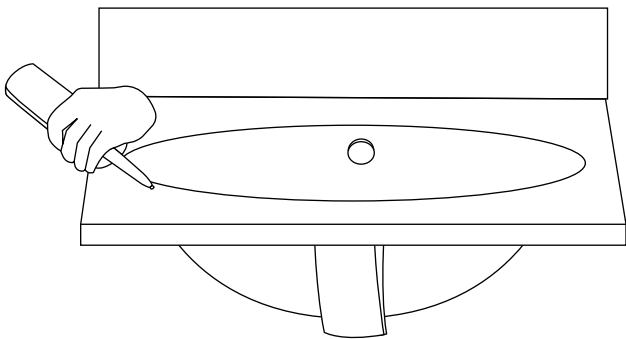

6. Proceed to the installation of your drain and faucet. Allow 24 hours for the silicone sealant to fully dry.



Undermount Installation

1. Carefully turn the counter top over, resting it on a soft, stable surface to prevent damage.

Important: The counter top is very fragile. Take caution when handling, and have someone assist if needed.

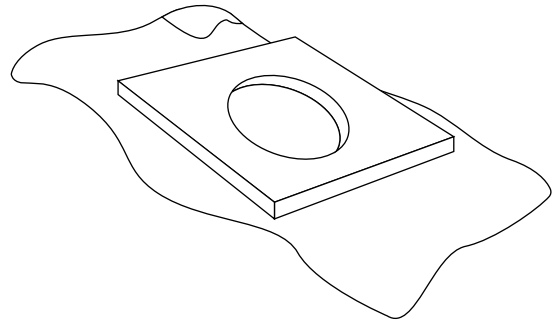

2. Position the sink over its cutout on the counter top. Make sure the sink is centered with the faucet hole and is evenly spaced between the bolt holes.

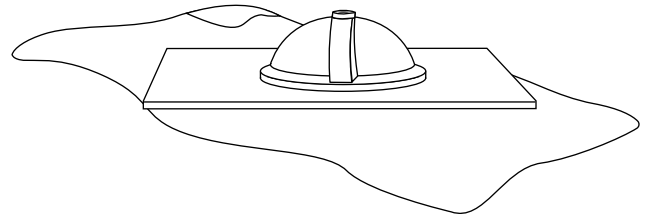



COPPER DROP-IN/UNDERMOUNT SINK

3. Use a pencil to draw an outline around the sink perimeter.

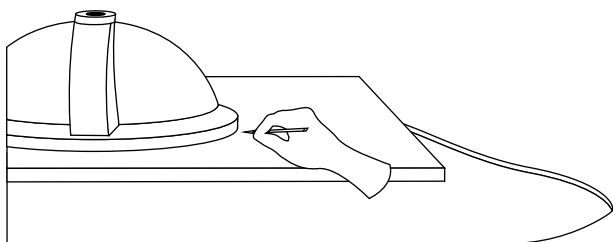

4. Remove the sink from the counter top. Apply a bead of silicone sealant around the top edge of the sink rim.

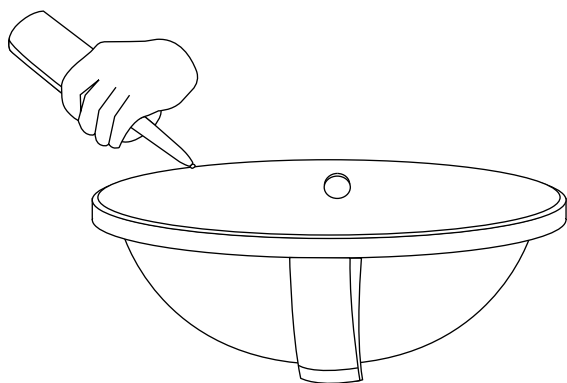

5. Carefully place the sink upside down on the counter top, positioning it within your marked outline. Once positioned, press firmly into place.

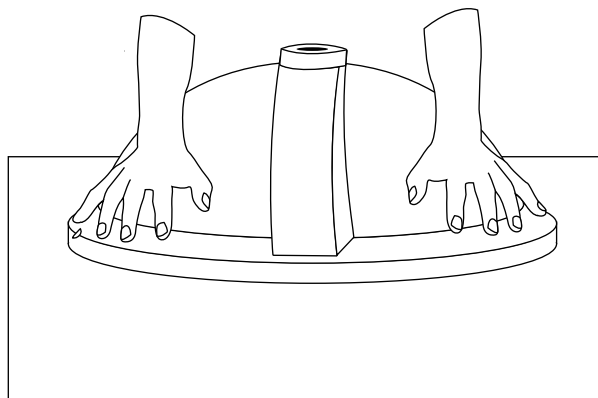

6. If sink clips were included, at each of the bolt holes in the counter top, attach the sink clips by placing the long end of the bracket flat against the sink lip. Screw the wing bolts through the brackets and bolt holes and tighten.

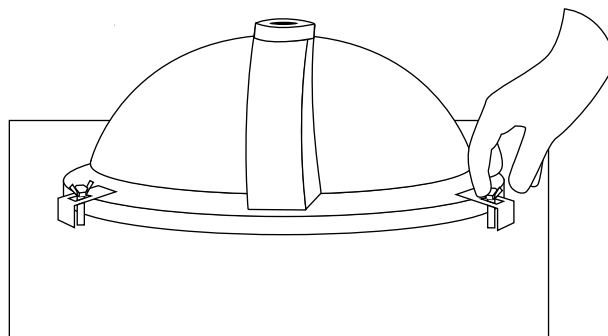



COPPER DROP-IN/UNDERMOUNT SINK

7. Carefully turn the counter top and sink over. If needed, reposition the sink by slightly loosening the wing bolts and adjusting.

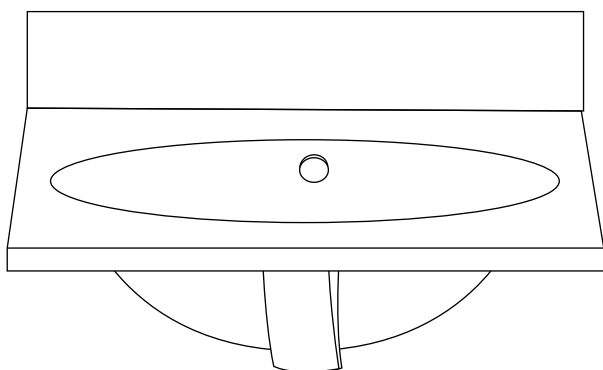

8. Wipe away any excess sealant with a damp cloth, and proceed to installing the counter top. Allow 24 hours for the silicone sealant to fully dry.

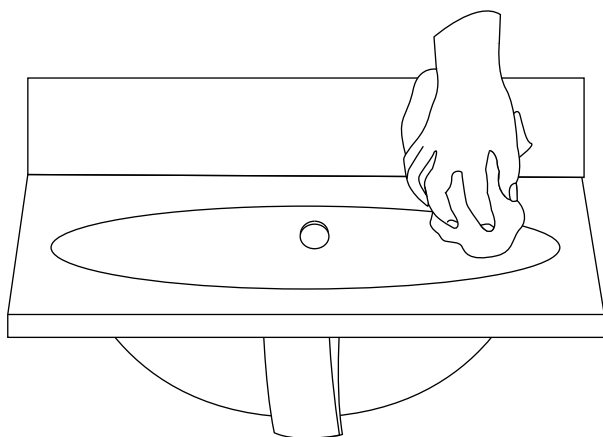

Cleaning and Maintenance

To protect the copper finish, it is recommended that a coating of wax is applied to the sink. Most wax products have natural and added UV filters that help guard against color and finish degradation. Wax should be applied as often as necessary, depending upon usage.

It is recommended that you use a cleaner or polish that is designed specifically for copper products. You may use a gentle soap, such as dishwashing liquid and warm water. We recommend the use of a soft sponge or microfiber washcloth. Do not use any abrasive cleaning pads or materials. Rinse with warm water and dry with a clean, soft cloth.

Acidic cleaners, such as lemon juice and vinegar, will strip the antique finish from the copper. Mixtures containing acidic chemicals should be avoided to preserve the finish.