



WALL-MOUNT BATHROOM SINK

BEFORE INSTALLING

Read entire installation instructions. Observe all local building and safety codes.

Unpack and inspect the product for any shipping damages. If you find damages, do not install. Contact Customer Service at 1-866-855-2284. If you need assistance or have questions while installing your sink, contact Customer Service.

Because wall construction and materials vary from home to home, Signature Hardware does not provide mounting hardware for all of our wall-mount sinks. The appropriate mounting hardware can be purchased from your local hardware store.

We recommend consulting a professional if you are unfamiliar with installing bathroom fixtures. Signature Hardware accepts no liability for any damage to the floor, walls, plumbing or for personal injury during installation.

TOOLS AND MATERIALS:

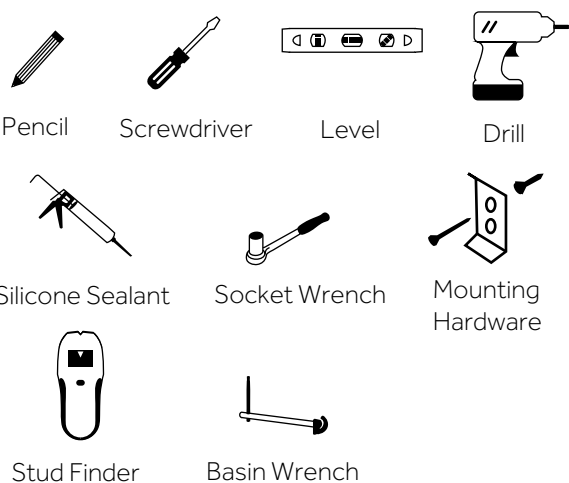

INSTALLATION

1. If no mounting bracket is provided, place the sink in the installation location and mark the wall through each of the mounting holes. For mounting bracket installation move on to page 2.

Important: The sink should be anchored to solid wood blocking installed behind the finished wall. We recommend consulting a professional if you are unfamiliar with this type of installation.

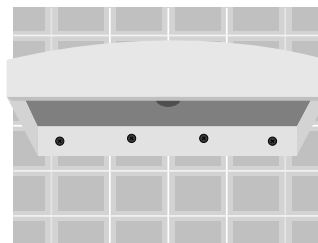

2. Drill mounting holes for the anchor or lag bolts using the guides created in the previous step. If the wall is tile, use a masonry drill bit.

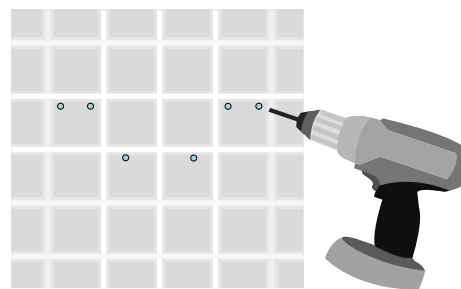

3. Install the new faucet and drain assembly according to the installation instructions.

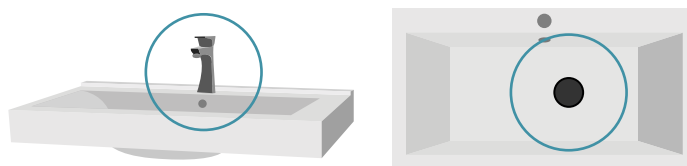

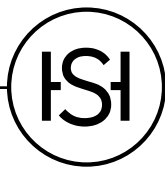

4. Secure the sink to the wall with the mounting hardware. After inserting the first fastener, verify that the sink is level. When the sink is properly aligned insert the remaining fasteners.

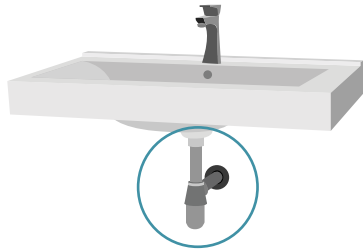

Note: Some wall-mount sinks include a trim piece to cover the plumbing lines. These typically attach directly to the wall framing with lag bolts.

5. Connect the water supply and drain lines. Turn on the water supply to check for any leaking from the water supply lines or sink basin. If a lavatory drain is included, move on to the **Drain Installation** section.

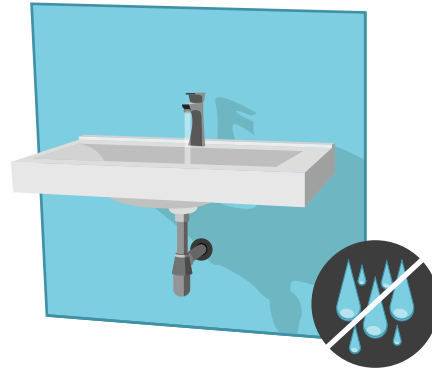

INSTALLATION (WITH MOUNTING BRACKET)

1. Place the mounting bracket(s) in the installation location and mark the wall through each of the mounting holes.

Important: The sink should be anchored to solid wood blocking installed behind the finished wall. We recommend consulting a professional if you are unfamiliar with this type of installation.

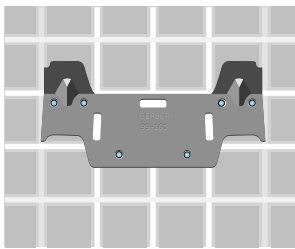

2. Drill mounting holes for the anchor or lag bolts using the guides created in the previous step. If the wall is tile, use a masonry drill bit.

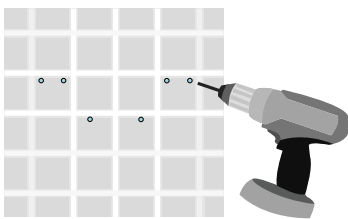

3. Secure the mounting bracket(s) to the wall with the anchor bolts. After inserting the first fastener, verify that the bracket(s) is level. When the bracket(s) is properly aligned insert the remaining fasteners.

4. Install the new faucet and drain assembly according to the installation instructions.

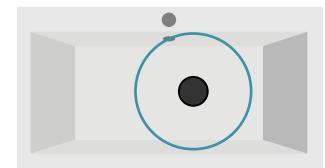
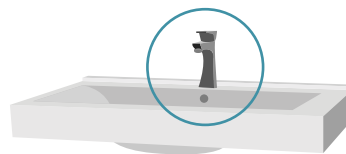

5. Attach the sink to the wall and brackets with the mounting hardware.





Note: Some wall-mount sinks include a trim piece to cover the plumbing lines. These typically attach directly to the wall framing with lag bolts.

6. Connect the water supply and drain lines. Turn on the water supply to check for any leaking from the water supply lines or sink basin. If a lavatory drain is included, move on to the **Drain Installation** section.

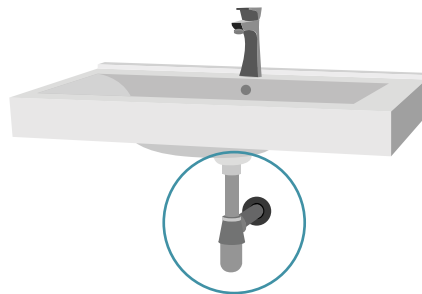

DRAIN INSTALLATION

1. Disassemble the drain by removing the threaded tail piece, rubber sealing gaskets, friction washer and lock nut from the drain body.

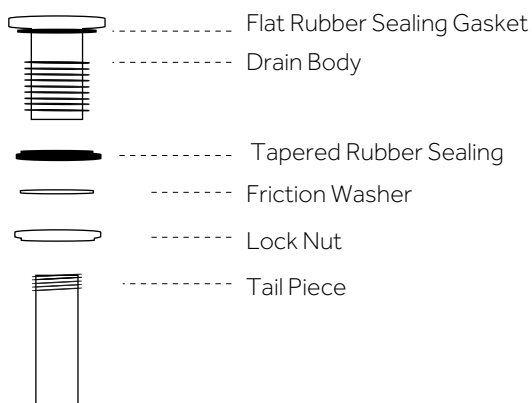

2. Place thread sealant on the threaded section of the tail piece and reattach to the drain body.

3. Slide the flat rubber sealing gasket up the tail piece to the top of the drain body. This gasket will create a water tight seal between the drain flange and sink.

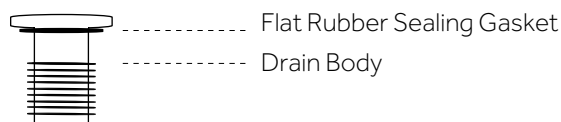

4. Place the drain in the drain hole in the sink.

5. On the underside of the counter, attach the tapered rubber gasket. With the flat side facing down, slide the gasket up the threaded shank until it makes contact with the bottom of the sink.

6. Slide the friction washer up to meet the rubber gasket.

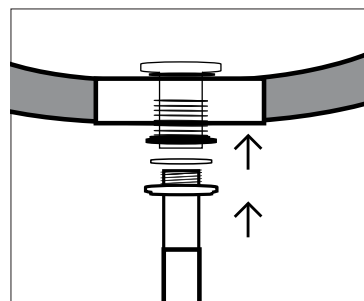

7. Thread the lock nut onto the threaded shank. Hand-tighten and make sure that the drain is properly aligned. When ready, finish tightening with a basin wrench to secure the drain.

