



BENNETT KITCHEN FAUCET INSTALLATION

BEFORE YOU BEGIN

We recommend consulting a professional if you are unfamiliar with installing plumbing fixtures. Signature Hardware accepts no liability for any damage to the faucet, plumbing, sink, counter top, or for personal injury during installation.

Observe all local plumbing and building codes.

Unpack and inspect the faucet for shipping damage. If any damage is found, contact our Customer Relations team at 1-866-855-2284.

Note: Make sure to winterize your outdoor faucet before cold weather arrives to prevent burst pipes and protect the faucet's hardware.

GETTING STARTED

- Ensure that you have gathered all the required materials that are needed for the installation.
- For these instructions, it is assumed that the old faucet has been completely removed and any necessary repairs or modifications to the water supply have been completed.

TOOLS AND MATERIALS:



Plumbers Tape*



Thread Sealant*



Phillips Screwdriver*



Adjustable Wrench*



Small Bucket*



Basin Wrench*

*not included

INSTALLATION

1. Ensure that the water supply below your sink is completely shut off by turning the shutoff valves all the way to the right.

Tip: Place a small bucket below your workspace to catch any water that may drip during the installation process.

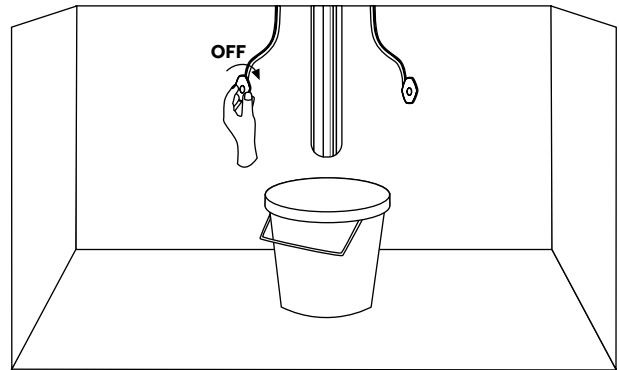

2. Remove the lock nut, rubber washer, and metal washer from the faucet body. Insert the faucet through the mounting hole in your counter top.

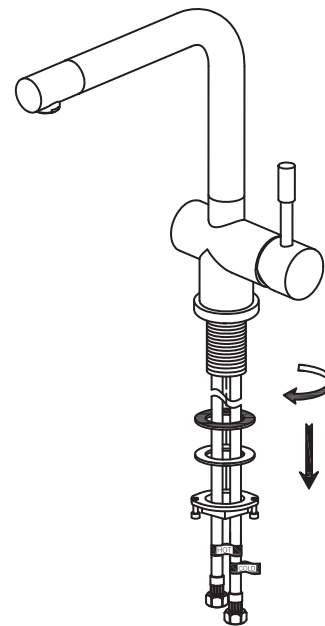



BENNETT KITCHEN FAUCET INSTALLATION

3. From beneath the sink, slide the rubber washer and metal washer back onto the faucet body. Thread the lock nut back onto the shank and hand tighten. Finish securing the faucet by tightening the two screws attached to the lock nut with a Phillip's screwdriver.

Note: For thin mounting surfaces, use the provided plastic support. The support should slide on first, before the rubber gasket.

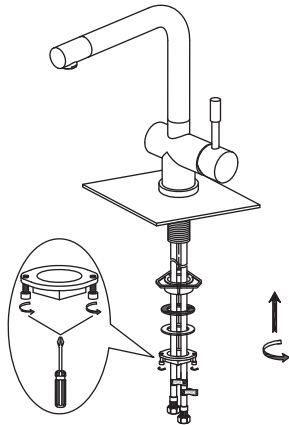

4. Apply plumber's tape or thread sealant to the threading on each of the faucet's water lines, and connect the main water hoses to the faucet. Ensure that you are connecting the hot and cold lines appropriately.

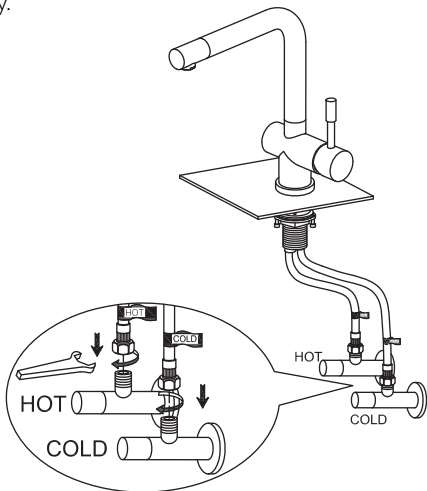

5. Once installation is complete, turn the main water supply back on from underneath your sink. Check for any leaks underneath.

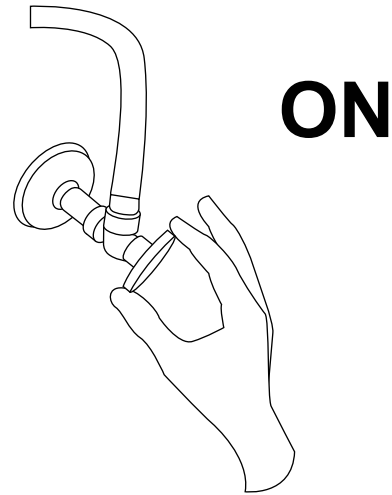

6. Remove the aerator from the spout. Turn the faucet on and allow the water to flow for approximately 60 seconds. Ensure that there are no leaks, and that both hot and cold water are running properly. Divert water to the sprayer setting and allow it to flow for another 60 seconds.

