



DROP-IN/UNDERMOUNT FIRECLAY SINK INSTALLATION

BEFORE YOU BEGIN

We recommend consulting a professional if you are unfamiliar with installing this type of product. Signature Hardware accepts no liability for any damage to the faucet, plumbing, sink, counter top, or for personal injury during installation.

Observe all local plumbing and building codes.

Unpack and inspect the product for shipping damage. If any damage is found, contact our Customer Relations team at 1-855-715-1800.

GETTING STARTED

- Ensure that you have gathered all the required materials that are needed for the installation.
- For these instructions, it is assumed that the old sink has been removed, and the area is prepared for new sink installation.

TOOLS AND MATERIALS:



Phillips
Screwdriver



Tape Measure



Cloth



Pencil



Silicone Sealant
(100% Neutral
Cure)



Safety Glasses



Level



DROP-IN/UNDERMOUNT FIRECLAY SINK INSTALLATION

DROP-IN INSTALLATION

1. Test-fit the sink by lowering it into the prepared cutout in the counter. The perimeter of the sink rim should sit flush on the counter. Remove the sink.

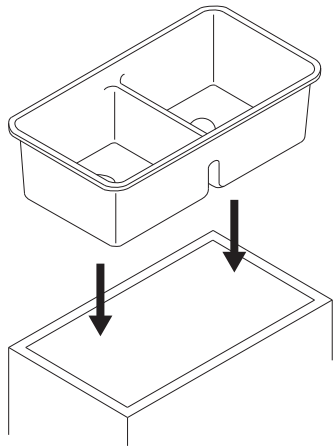

2. Turn the sink over and apply a generous bead of silicone sealant along the bottom of the sink rim.

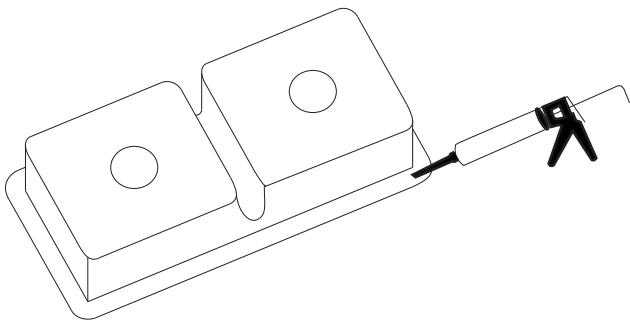

3. Carefully lower the sink back into its prepared cutout. Press firmly into place. Ensure that the sink is level and properly aligned. Wipe away any excess silicone around the rim of the sink with a damp cloth.

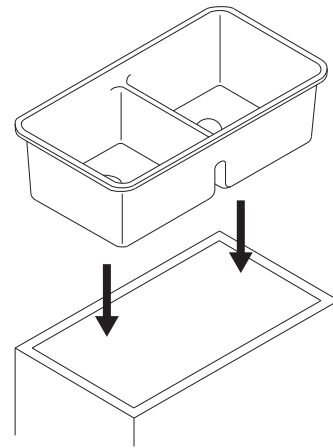

4. Proceed to the installation of the sink drain and faucet. Allow the silicone up to 24 hours to fully dry.

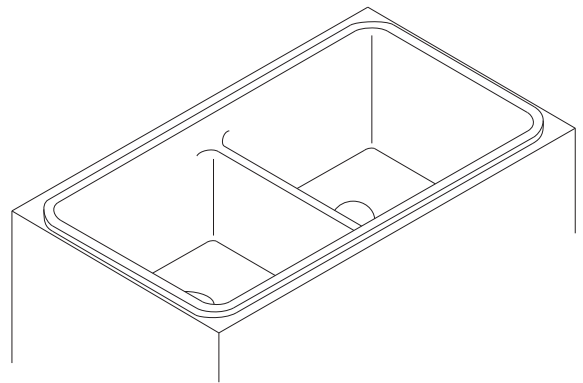



DROP-IN/UNDERMOUNT FIRECLAY SINK INSTALLATION

UNDERMOUNT INSTALLATION

1. Construct a wooden frame to support the sink. Measure your sink to determine the dimensions.

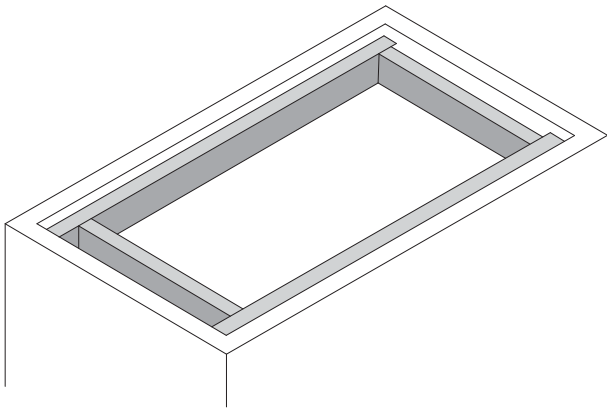

2. Turn the sink over and apply a generous bead of silicone sealant along the bottom of the sink rim.

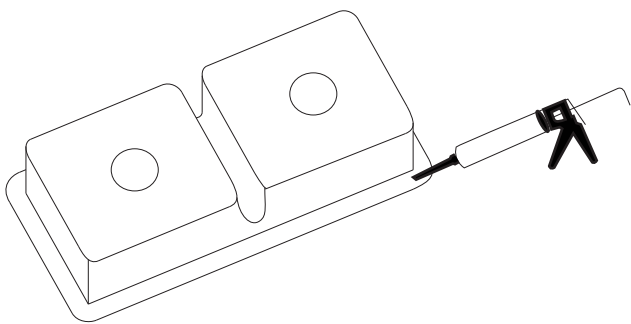

3. Set the sink into the wood framing that was constructed in step 1. Press firmly into place.

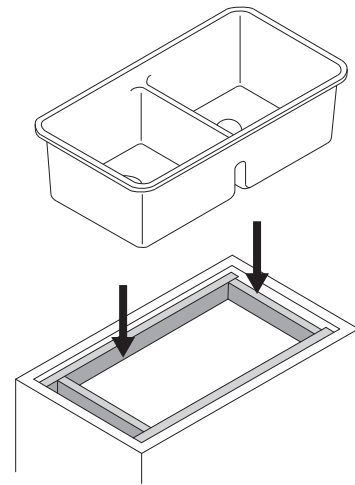

4. Apply a generous bead of silicone along the top of the sink rim, then proceed to installing the countertop. Once the counter is in place, fill any gap between the sink and the counter with silicone. Wipe away any excess silicone with a damp cloth.

